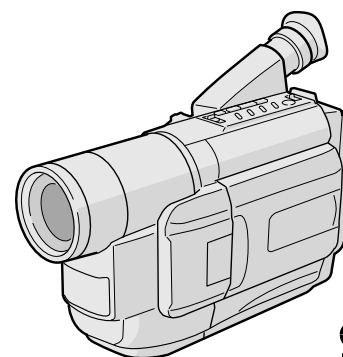

EN**JVC**GR-SXM930
GR-SXM530**COMPACT
VHS CAMCORDER****GR-SXM930
GR-SXM530****JVC**
VICTOR COMPANY OF JAPAN, LIMITED**DSC**
DIGITAL
STILL CAMERA**SVHS**
Super VHS
*Super VHS ET***INSTRUCTIONS****For Customer Use:**

Enter below the Model No. and Serial No. which is located on the bottom of cabinet. Retain this information for future reference.

Model No. _____

Serial No. _____

ENGLISH

CONTENTS**SAFETY PRECAUTIONS 2 - 3****PROVIDED ACCESSORIES 4****AUTOMATIC
DEMONSTRATION 6****GETTING STARTED 7 - 16****VIDEO RECORDING &
PLAYBACK 17 - 26**

VIDEO RECORDING 18 - 21

VIDEO PLAYBACK 22 - 26

**DIGITAL STILL CAMERA (D.S.C.)
RECORDING &
PLAYBACK 27 - 34**

D.S.C. RECORDING 28 - 29

D.S.C. PLAYBACK 30 - 34

**ADVANCED
FEATURES 35 - 53****REFERENCES 54 - 75**

TROUBLESHOOTING 55 - 57

DETAILS 58 - 59

INDEX 60 - 63

TERMS 64 - 65

CAUTIONS 66 - 68

SPECIFICATIONS 69

ESPAÑOL 70 - 73

**FOR SERVICING
(Only in U.S.A.) 74****WARRANTY
(Only in U.S.A.) 75****EN**

Dear Customer,

Thank you for purchasing the JVC Compact VHS camcorder. Before use, please read the safety information and precautions contained in the following pages to ensure safe use of this product.

Using This Instruction Manual



- All major sections and subsections are listed in the Table Of Contents on the cover.
- Notes appear after most subsections. Be sure to read these as well.
- Basic and advanced features/operation are separated for easier reference.

It is recommended that you . . .

- refer to the Index (☞ pgs. 60 – 63) and familiarize yourself with button locations, etc. before use.
- read thoroughly the Safety Precautions and Safety Instructions that follow. They contain extremely important information regarding the safe use of this product.

You are recommended to carefully read the cautions on pages 66 – 68 before use.

SAFETY PRECAUTIONS

	CAUTION RISK OF ELECTRIC SHOCK DO NOT OPEN	
<p>CAUTION: TO REDUCE THE RISK OF ELECTRIC SHOCK, DO NOT REMOVE COVER (OR BACK). NO USER-SERVICEABLE PARTS INSIDE. REFER SERVICING TO QUALIFIED SERVICE PERSONNEL.</p>		

WARNING:

TO REDUCE THE RISK OF FIRE OR ELECTRIC SHOCK, DO NOT EXPOSE THIS APPARATUS TO RAIN OR MOISTURE.



The lightning flash with arrowhead symbol, within an equilateral triangle, is intended to alert the user to the presence of uninsulated "dangerous voltage" within the product's enclosure that may be of sufficient magnitude to constitute a risk of electric shock to persons.



The exclamation point within an equilateral triangle is intended to alert the user to the presence of important operating and maintenance (servicing) instructions in the literature accompanying the appliance.

NOTES:

- *The rating plate (serial number plate) and safety caution are on the bottom and/or the back of the main unit.*
- *The rating information and safety caution of the AC Adapter are on its upper and lower sides.*

CAUTIONS:

- This camcorder is designed to be used with NTSC-type color television signals. It cannot be used for playback with a television of a different standard. However, live recording and LCD monitor/viewfinder playback are possible anywhere.
- Use the JVC BN-V11U/V12U/V20U/V400U battery packs and, to recharge them or to supply power to the camcorder from an AC outlet, use the provided multi-voltage AC Adapter. (An appropriate conversion adapter may be necessary to accommodate different designs of AC outlets in different countries.)

ATTENTION:

The product that you have purchased is powered by a rechargeable battery. The battery is recyclable. At the end of its useful life, under various state and local laws, it may be illegal to dispose of this battery into the municipal waste stream. Check with your local solid waste officials for details in your area for recycling options or proper disposal.



Cassettes marked **SVHS** and **VHS** can be used with this camcorder.

The EPA certified RBRC® Battery Recycling Seal on the nickel-cadmium (Ni-Cd) battery indicates JVC is voluntarily participating in an industry program to collect and recycle these batteries at the end of their useful life, when taken out of service in the United States. The RBRC® program provides a convenient alternative to placing used Ni-Cd batteries into the trash or the municipal waste stream, which may be illegal in your area. Please call 1-800-8-BATTERY™ for information on Ni-Cd battery recycling and disposal bans/restrictions in your area. JVC's involvement in this program is part of our commitment to preserving our environment and conserving our natural resources.

When the equipment is installed in a cabinet or on a shelf, make sure that it has sufficient space on all sides to allow for ventilation (10 cm (3-15/16") or more on both sides, on top and at the rear).

Do not block the ventilation holes.

(If the ventilation holes are blocked by a newspaper, or cloth etc. the heat may not be able to get out.)

No naked flame sources, such as lighted candles, should be placed on the apparatus.

When discarding batteries, environmental problems must be considered and the local rules or laws governing the disposal of these batteries must be followed strictly.

The apparatus shall not be exposed to dripping or splashing.

Do not use this equipment in a bathroom or places with water.

Also do not place any containers filled with water or liquids (such as cosmetics or medicines, flower vases, potted plants, cups etc.) on top of this unit.

(If water or liquid is allowed to enter this equipment, fire or electric shock may be caused.)

IMPORTANT SAFETY INSTRUCTIONS

- (1) Read these instructions.
- (2) Keep these instructions.
- (3) Heed all warnings.
- (4) Follow all instructions.
- (5) Do not use this apparatus near water.
- (6) Clean only with dry cloth.
- (7) Do not block any ventilation openings.
Install in accordance with the manufacturer's instructions.
- (8) Do not install near any heat sources such as radiators, heat registers, stoves, or other apparatus (including amplifiers) that produce heat.
- (9) Only use attachments/accessories specified by the manufacturer.
- (10) Use only with the cart, stand, tripod, bracket, or table specified by the manufacturer, or sold with the apparatus. When a cart is used, use caution when moving the cart/apparatus combination to avoid injury from tip-over.
- (11) Unplug this apparatus during lightning storms or when unused for long periods of time.
- (12) Refer all servicing to qualified service personnel. Servicing is required when the apparatus has been damaged in any way, such as power-supply cord or plug is damaged, liquid has been spilled or objects have fallen into the apparatus, the apparatus has been exposed to rain or moisture, does not operate normally, or has been dropped.



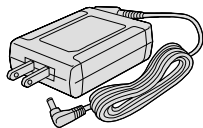

• AC Adapter
AP-V10U

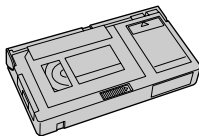

• Cassette Adapter
(VHS Playpak)
C-P7U

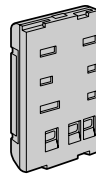

• Battery Pack
BN-V11U

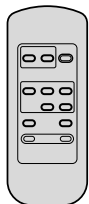

• Remote Control
Unit RM-V715U

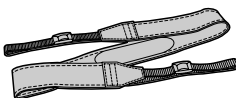

• Shoulder Strap



• Lens Cap

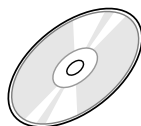

• CD-ROM
(GR-SXM930 only)
The CD-ROM contains
the following 4 software
programs:

- Picture Navigator
- Presto!
- Mr. Photo
- PhotoAlbum
- ImageFolio

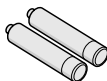

• AAA (R03) Battery x 2
(for Remote Control Unit)



• AA (R6) Battery
(for Cassette Adapter)



(for Windows® PC)

• PC Connection Cable
(GR-SXM930 only)

How To Attach The Lens Cap

To protect the lens, attach the provided lens cap to the camcorder as shown in the illustration.

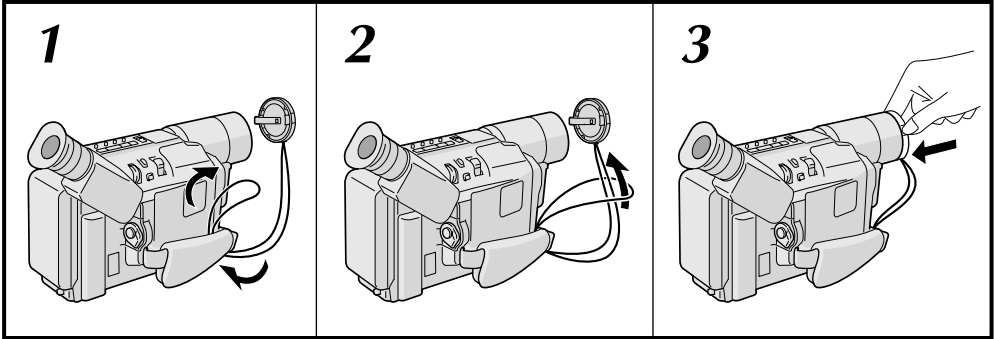

Automatic Demonstration takes place when “DEMO MODE” is set to “ON” (factory-preset).

- Available when the Power Switch is set to “**A**” or “**M**” and the VIDEO mode is selected (the DSC Lamp is not lit).
- Operating the Power Zoom Lever during the demonstration stops the demonstration temporarily. If the Power Zoom Lever is not moved for more than 1 minute after that, the demonstration will resume.
- “DEMO MODE” remains “ON” even if the camcorder power is turned off.
- To cancel Automatic Demonstration, set the Power Switch to “**M**” and Press the **MENU** Wheel in while the demo is in progress. This takes you directly to the demo mode’s Setting Menu (so you will not have to go through the main Menu Screen). Rotate the **MENU** Wheel to select “OFF” and press it.

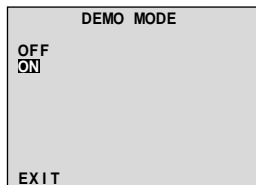

Setting Menu

NOTES:

- When a tape whose Erase Protection tab is in the position that allows recording is loaded in the camcorder, demonstration is not available.
- If you do not detach the Lens Cap, you cannot see the actual changes of the Automatic Demonstration activated on the LCD monitor or viewfinder.

GETTING STARTED**CONTENTS**

Power	8 – 9
Grip Adjustment	10
Viewfinder Adjustment	10
Shoulder Strap Attachment	10
Tripod Mounting	10
Date/Time Settings	11
Recording Format Setting	12 – 13
Recording Mode Setting	14
Tape Length Setting	14
Loading/Unloading A Cassette	15
Picture Mode Setting	16

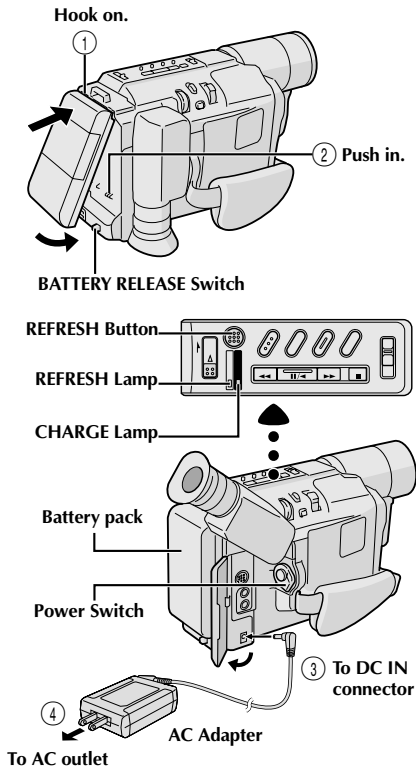

Battery pack	Charging time
BN-V11U	approx. 1 hr. 30 min.
BN-V12U (optional)	approx. 1 hr. 30 min.
BN-V20U (optional)	approx. 2 hrs. 20 min.
BN-V400U (optional)	approx. 4 hrs. 30 min.

REFRESH:

Charging a battery with some charge remaining reduces that battery's capacity. Perform the procedure below to fully discharge the battery pack before recharging.

1. Perform steps 1 through 3 of "CHARGING THE BATTERY PACK".
2. Press **REFRESH** on the camcorder for over 2 seconds. The REFRESH lamp on the camcorder blinks to indicate discharging has started.
3. When discharging is finished, charging automatically starts and the CHARGE lamp blinks.

When you are not using a battery pack for a long period of time, be sure to fully discharge it before storing because leaving a battery with some charge left over also reduces performance.

Power

This camcorder's 2-way power supply system lets you choose the most appropriate source of power. Do not use provided power supply units with other equipment.

CHARGING THE BATTERY PACK

- 1 Make sure the battery pack is attached to the camcorder. Hook its end to the camcorder ① and push the battery in until it locks in place ②.
 - If the battery pack is attached in the wrong position, a malfunction may occur.
- 2 Set the Power Switch to "OFF". Connect the AC Adapter to the camcorder ③.
- 3 Plug the AC Adapter into an AC outlet ④. The CHARGE lamp on the camcorder blinks to indicate charging has started.
- 4 When the CHARGE lamp stops blinking but stays lit, charging is finished. Unplug the AC Adapter from the AC outlet. Disconnect the AC Adapter from the camcorder.

To Detach The Battery Pack . . .

.... slide **BATTERY RELEASE** and pull out the battery pack.

NOTES:

- During charging or discharging, the camcorder cannot be operated.
- Charging and discharging is not possible if the wrong type of battery is used.
- When charging the battery pack for the first time or after a long storage period, the CHARGE lamp may not light. In this case, remove the battery pack from the camcorder, then try charging again.
- If the battery operation time remains extremely short even after having been fully charged, the battery is worn out and needs to be replaced. Please purchase a new one.
- Using the optional AA-V15 AC Power Adapter/Charger, you can charge the BN-V11U/V12U/V20U/V400U battery pack without the camcorder. However, it cannot be used as an AC adapter.

ATTENTION:

Before detaching the power source, make sure that the camcorder's power is turned off. Failure to do so can result in a camcorder malfunction.

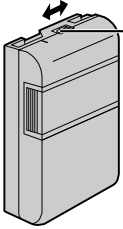
**Charge marker**

A charge marker is provided on the battery pack to help you remember whether it has been charged or not. Two colors are provided (red and black)—you choose which one means charged and which means discharged.

USING THE BATTERY PACK

Perform step 1 of "CHARGING THE BATTERY PACK" (pg. 8).

Approximate recording time (unit: min.)

Battery pack	Viewfinder on	LCD monitor on
BN-V11U	80 (45)	65 (35)
BN-V12U (optional)	80 (45)	65 (35)
BN-V20U (optional)	130 (75)	105 (60)
BN-V400U (optional)	305 (185)	245 (160)

() : when the video light is on

NOTES:

- Recording time is reduced significantly under the following conditions:
 - Zoom or Record-Standby mode is engaged repeatedly.
 - The LCD monitor is used repeatedly.
- Before extended use, it is recommended that you prepare enough battery packs to cover 3 times the planned shooting time.

USING AC POWER

Use the AC Adapter (connect as shown in the illustration).

NOTES:

- The provided AC Adapter features automatic voltage selection in the AC range from 110 V to 240 V.
- For other notes, pg. 58.

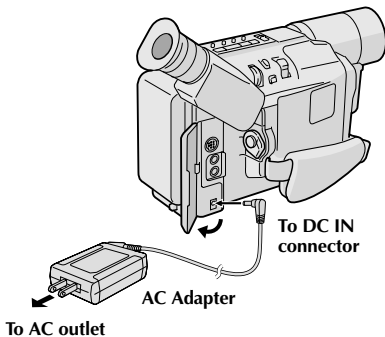

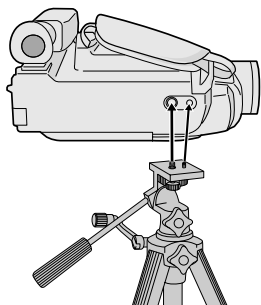
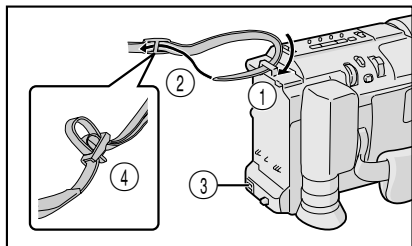
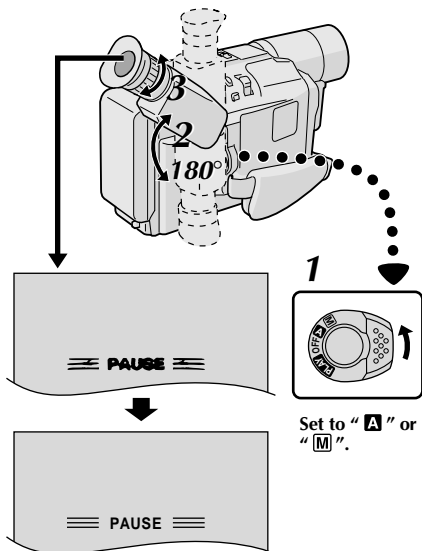
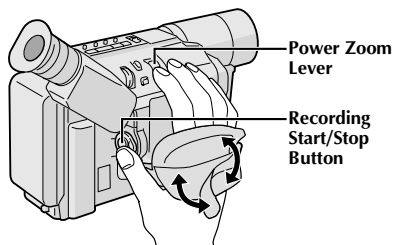

Grip Adjustment

- 1 Separate the Velcro strip.
- 2 Pass your right hand through the loop and grasp the grip.
- 3 Adjust so that your thumb and fingers can easily operate the Recording Start/Stop Button and Power Zoom Lever. Refasten the Velcro strip.

Viewfinder Adjustment

- 1 Set the Power Switch to "A" or "M".
- 2 Adjust the viewfinder manually for best viewability.
- 3 Turn the Diopter Adjustment Control until the indications in the viewfinder are clearly focused.

Shoulder Strap Attachment

- 1 Following the illustration, thread the strap through the eyelet (1), then fold it back and thread it through the buckle (2). Repeat the procedure to attach the other end of the strap to the other eyelet (3), making sure the strap is not twisted.
- 2 Adjust as shown in the illustration (4).

Tripod Mounting

- 1 Align the screw and camera direction stud on the tripod with the camera's mounting socket and stud hole. Then tighten the screw.

CAUTION:

When using a tripod, be sure to open and extend its legs fully to Stabilize the camcorder. To prevent damage to the unit caused by falling over, do not use a small-sized tripod.

Date/Time Settings

- 1 Set the Power Switch to "M". The VIDEO Lamp comes on.
- 2 Press the MENU Wheel in. The Menu Screen appears.
- 3 Rotate the MENU Wheel to select "▶ TO SYSTEM MENU" and press it to display SYSTEM MENU. Rotate the MENU Wheel to select "▶ NEXT" and press it to display the next page.
- 4 Rotate the MENU Wheel to select "DATE/TIME" and press it. The DATE/TIME Menu appears.
- 5 To set "YEAR", "MONTH", "DAY" or "TIME" (hour/minute), rotate the MENU Wheel to select the desired item, and press it. When the setting begins blinking, rotate the MENU Wheel until the correct setting appears and then press it. The setting stops blinking.
- 6 When none of these settings ("YEAR", "MONTH", "DAY", "TIME") blinks, rotate the MENU Wheel to select "EXIT", and press it. The Menu Screen reappears with the highlight bar on "▶ RETURN".
- 7 Press the MENU Wheel in to close the Menu Screen.

NOTE:

To display the date and time in the camcorder's display and on a connected TV, see "Date/Time Insert" (pg. 47).

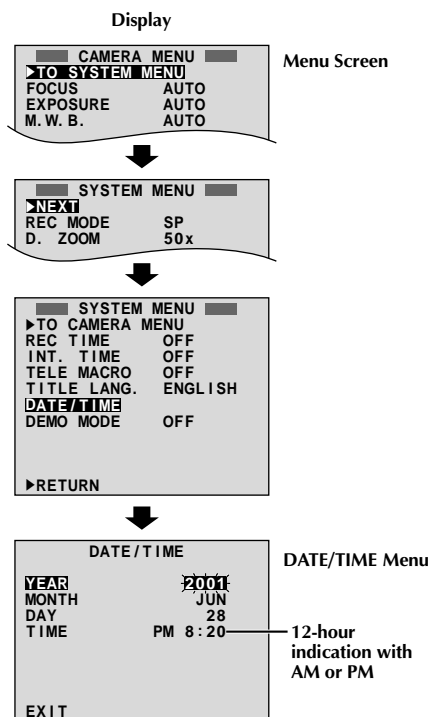
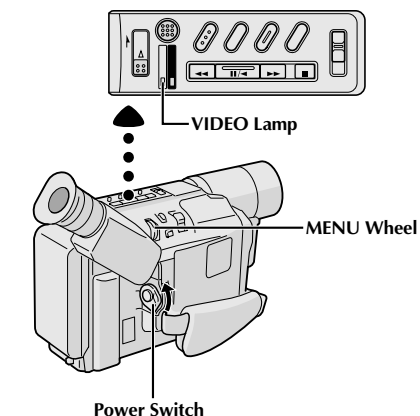

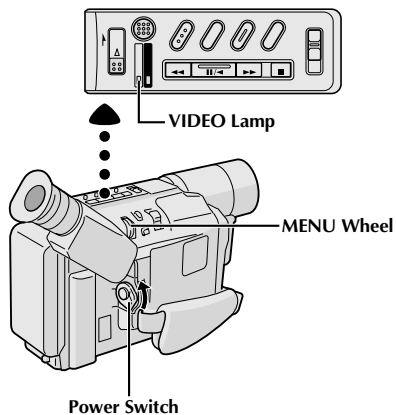

Display: when a VHS cassette is loaded.

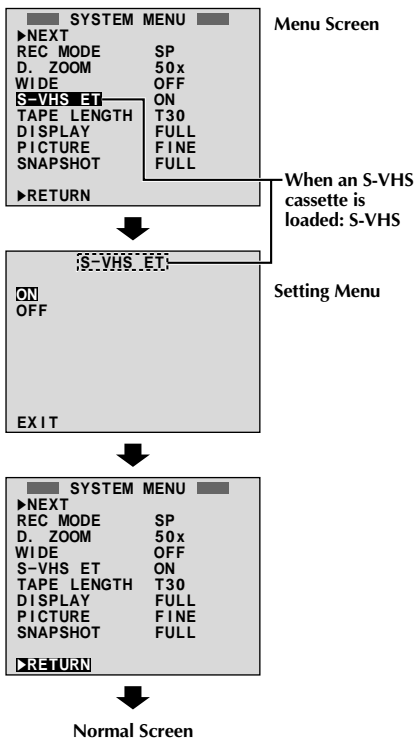

Recording Format Setting

Set the recording format according to the format of the tape used or type of recording you wish to perform.

- 1** Set the Power Switch to "M". The VIDEO Lamp comes on.
- 2** Press the MENU Wheel in. The Menu Screen appears.
- 3** Rotate the MENU Wheel to select "▶ TO SYSTEM MENU" and press it to display SYSTEM MENU.
If a VHS cassette is loaded . . .
 rotate the MENU Wheel to select "S-VHS ET", then press it. The S-VHS ET Setting Menu appears.
If an S-VHS cassette is loaded . . .
 rotate the MENU Wheel to "S-VHS", then press it. The S-VHS Setting Menu appears.
- 4** Rotate the MENU Wheel to set to either of the parameters, then press it. The Menu Screen reappears with the highlight bar on "▶ RETURN".
In the S-VHS ET Setting Menu,
ON : Records with S-VHS picture quality on a VHS cassette (factory-preset). This is called Super VHS ET (Expansion Technology).
OFF : Records in VHS.
In the S-VHS Setting Menu,
ON : Records in S-VHS on an S-VHS cassette (factory-preset).
OFF : Records in VHS on an S-VHS cassette.
- 5** Press the MENU Wheel in to close the Menu Screen.
 - When the S-VHS ET mode is engaged, "S-ET" is displayed.
 - During S-VHS record mode, "S" is displayed.
 - When S-VHS ET or S-VHS recording starts, "S-VHS REC" is displayed for approx. 3 seconds.

NOTE:

If a cassette is not loaded, "S-VHS" will be displayed in the Menu Screen.

NOTES about S-VHS and S-VHS ET

- JVC EHG (Extra High Grade) tapes are recommended for superior results.
Use S-VHS tape for storing recordings for an extended period or for recording important scenes, as it enables higher-quality recording and playback.
- With some tapes, better picture quality may not be obtained even with S-VHS ET recording. It is recommended that you do test record beforehand to make sure whether better results can be obtained.
- If the S-VHS ET mode or recording format is switched during recording, the playback picture will be blurred at the switching point.
- It is recommended that tapes recorded in the SP mode on this camcorder be played back on this camcorder.
- Noise may appear on-screen when tapes recorded in the EP mode are played back.
- Tapes recorded in S-VHS or S-VHS ET mode can be played back not only on this camcorder but also on a Super VHS VCR or a VCR equipped with the SQPB (S-VHS QUASI PLAYBACK) function.
 - When tapes recorded in S-VHS or S-VHS ET mode are played back on a VCR equipped with the SQPB (S-VHS QUASI PLAYBACK) function, S-VHS picture quality is not available.
 - Tapes recorded in S-VHS ET mode cannot be played back on some VCRs, including some JVC VCRs (eg: HR-S6600U, HR-SC1000U, etc.).
- Tapes recorded in S-VHS or S-VHS ET mode cannot be played back correctly on a normal VHS VCR.
- You can play back S-VHS ET recordings not only on this camcorder but also on another VHS VCR equipped with S-VHS ET.
 - It is recommended to specifically label S-VHS ET recordings so you can easily distinguish them from regular VHS recordings.
- S-VHS ET does not work with S-VHS tapes.
- To avoid on-screen noise, do not perform Still Playback or Shuttle Search repeatedly.
- If the picture contains a lot of jitter or noise, use a cleaning cassette.

Compatibility Between S-VHS And VHS

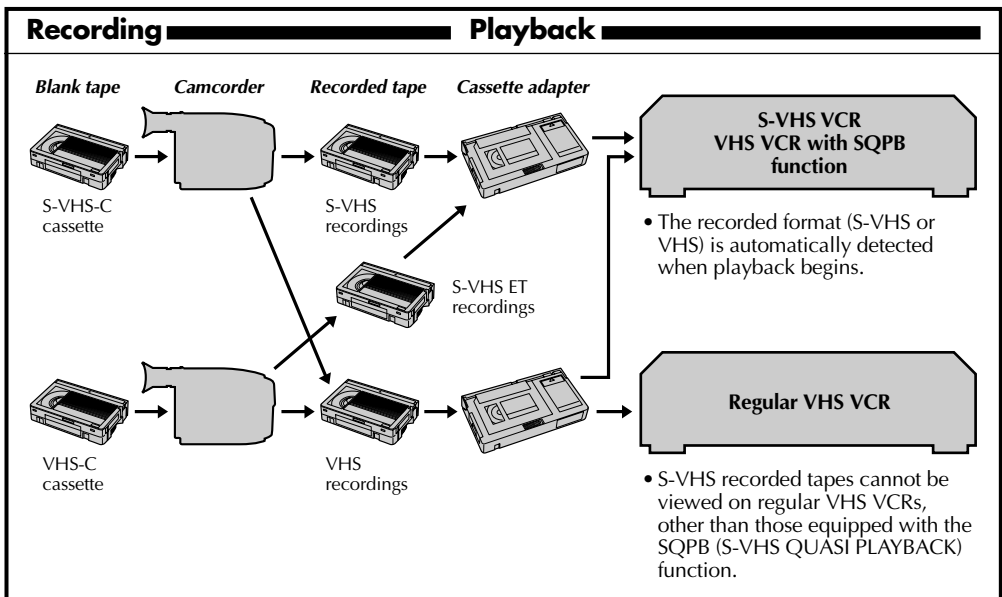

Recording Mode Setting

Set the tape recording mode depending on your preference.

- 1** Set the Power Switch to "M". The VIDEO Lamp comes on.
- 2** Press the MENU Wheel in. The Menu Screen appears.
- 3** Rotate the MENU Wheel to select "▶ TO SYSTEM MENU" and press it to display SYSTEM MENU.
- 4** Rotate the MENU Wheel to select "REC MODE" and press it. The REC MODE Menu appears. Select "SP" or "EP" by rotating the MENU Wheel and press it. The Menu Screen reappears with the highlight bar on "▶ RETURN". Press the MENU Wheel in to close the Menu Screen.
 - "EP" (Extended Play) is more economical, providing three times the recording time.

NOTE:

If the recording mode is switched during recording, the playback picture will be blurred at the switching point.

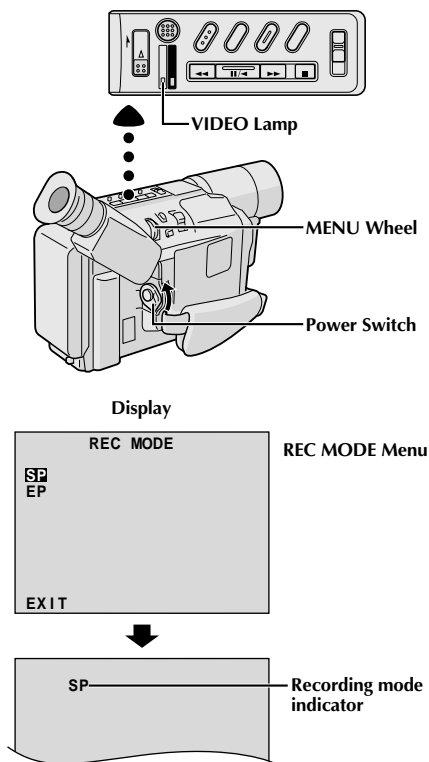

Tape Length Setting

Set the tape length according to the length of the tape used.

- 1** Perform steps 1 through 3 above.
- 2** Rotate the MENU Wheel to select "TAPE LENGTH", then press it. The TAPE LENGTH Menu appears.
- 3** Rotate the MENU Wheel to select the correct tape length setting.
 - T20=20 minutes
 - T30=30 minutes
 - T35=35 minutes
 - T40=40 minutes (in SP)
- 4** Press the MENU Wheel in. The Menu Screen reappears with the highlight bar on "▶ RETURN". Press the MENU Wheel in to close the Menu Screen.

NOTE:

The tape remaining time (pg. 18) is correct only if the correct tape length has been selected.

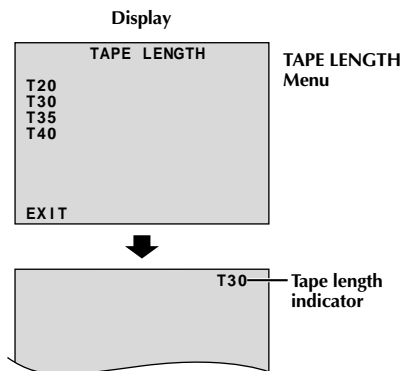

Loading/Unloading A Cassette

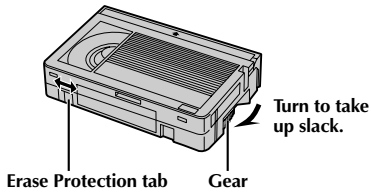
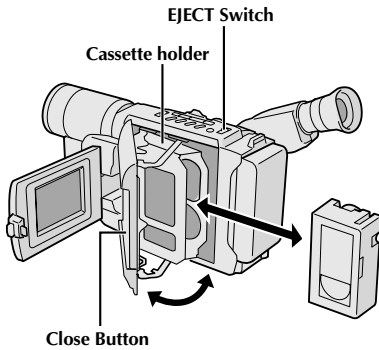

- 1 Open the LCD monitor fully.
- 2 Slide **EJECT** until the cassette holder opens. Do not use force to open.
- 3 Insert or remove a cassette. When inserting, make sure the label is facing outward.
- 4 Press the Close button to close the cassette holder until it locks into place.
- 5 Close the LCD monitor.

NOTES:

- Closing the LCD monitor while the cassette holder is still open may cause damage to the LCD monitor.
- The cassette holder can't be opened unless a power supply is attached.
- Make sure that the tape is not slack when loading the cassette. If there is any slack, turn the gear in the direction of the arrow to take up the slack.
- Make sure the Erase Protection tab is in the position that allows recording. If not, slide the tab. Some cassettes have removable tabs. If the tab has been removed, cover the hole with adhesive tape.
- The cassette holder cannot be opened while the camcorder is in the record mode.

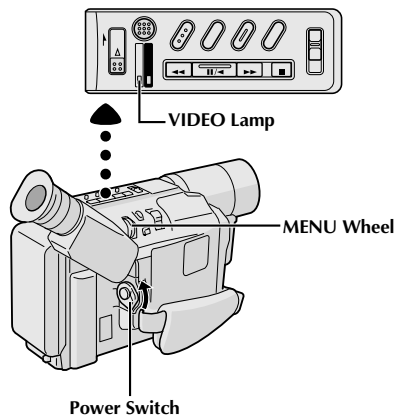

Picture Mode Setting

The Picture mode can be selected to best match your needs. Two Picture modes are available: FINE and STANDARD (in order of quality).

- 1** Set the Power Switch to "M". The VIDEO Lamp comes on.
- 2** Press the MENU Wheel in. The Menu Screen appears.
- 3** Rotate the MENU Wheel to select "▶ TO SYSTEM MENU" and press it to display SYSTEM MENU.
- 4** Rotate the MENU Wheel to select "PICTURE" and press it. The PICTURE Menu appears. Select "FINE" or "STANDARD" by rotating the MENU Wheel and press it. Selection is complete.
- 5** The Menu Screen reappears with the highlight bar on "▶ RETURN". Press the MENU Wheel in to close the Menu Screen.

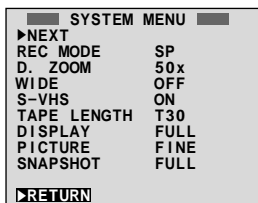
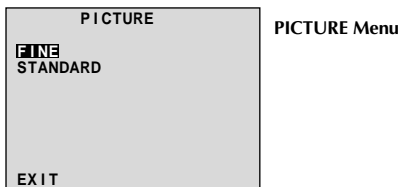
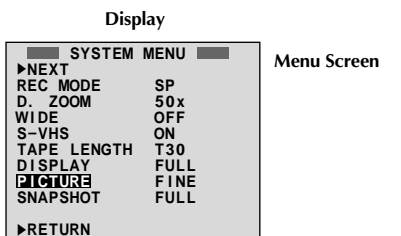

Normal Screen

Picture Quality Mode	Approximate Number of Storable Images
FINE	30
STANDARD	60

NOTES:

- The number of storable images depends on the selected Picture mode as well as the composition of the subjects in the images.
- The numbers listed above are applicable when the camcorder's memory is empty (when there are no sample images stored).

VIDEO RECORDING & PLAYBACK

CONTENTS

VIDEO RECORDING	18 – 21
Shooting While Watching The Viewfinder	18
Shooting While Watching The LCD Monitor	18
LCD Monitor Brightness Adjustment	18
Power Switch Position	18
Journalistic Shooting	19
Self-Recording	19
Zooming	20
Picture Stabilizer	20
Quick Review (for scenes recorded onto a tape)	21
Retake	21
Video Light	21
VIDEO PLAYBACK	22 – 26
LCD Monitor Brightness Adjustment	22
Speaker Volume Control	22
Still Playback	22
Shuttle Search	22
Tracking	23
TBC (Time Base Corrector)	23
Counter Memory Function	23
Playback Special Effects (GR-SXM930 only)	23
Basic Connections	24 – 25
Tape Dubbing	25
Using The Cassette Adapter (VHS Playpak)	26

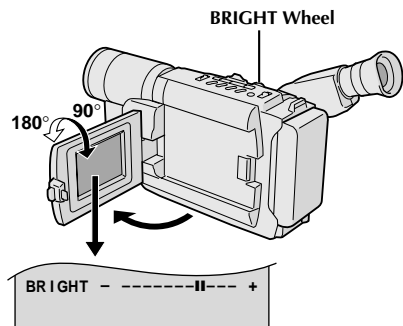
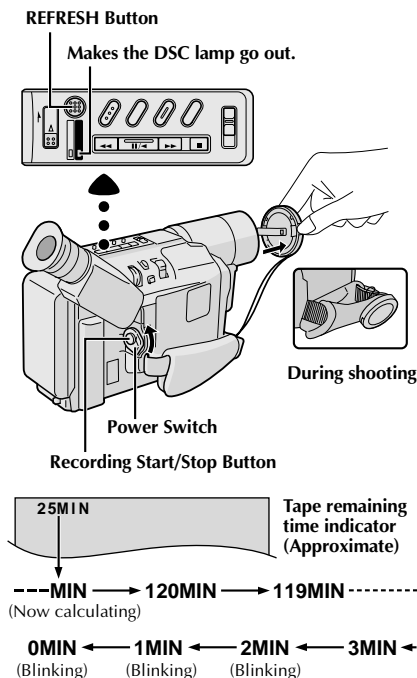

To Adjust The Brightness Of The LCD Monitor

.... rotate the **BRIGHT** Wheel until the bright level indicator on the display moves and the appropriate brightness is reached.

NOTE:

You should already have performed the procedures listed below. If not, do so before continuing.

- Power (☞ pg. 8)
- Load A Cassette (☞ pg. 15)
- Recording Mode Setting (☞ pg. 14)
- Tape Length Setting (☞ pg. 14)
- Grip Adjustment (☞ pg. 10)
- Viewfinder Adjustment (☞ pg. 10)

Shooting While Watching The Viewfinder

1 Make sure the LCD monitor is closed and locked. Press in the tabs on the lens cap to remove it. Set the Power Switch to "**A**" or "**M**". If the DSC Lamp is lit, press **REFRESH** for approx. 1 second to select "VIDEO". The VIDEO Lamp lights and the camcorder enters the Record-Standby mode. "PAUSE" is displayed in the viewfinder.

2 Press the Recording Start/Stop Button. "REC" appears in the viewfinder while recording is in progress.

To Stop Recording . . .

.... press the Recording Start/Stop Button. The camcorder re-enters the Record-Standby mode.

Shooting While Watching The LCD Monitor

1 Make sure the LCD monitor is fully open. Press in the tabs on the lens cap to remove it. Set the Power Switch to "**A**" or "**M**". If the DSC Lamp is lit, press **REFRESH** for approx. 1 second to select "VIDEO". The VIDEO Lamp lights and the camcorder enters the Record-Standby mode. "PAUSE" is displayed in the LCD monitor.

2 Tilt the LCD monitor upward/downward for best viewability and press the Recording Start/Stop Button. "REC" appears in the LCD monitor while recording is in progress.

NOTE:

When you use the LCD monitor outdoors in direct sunlight, the LCD monitor may be difficult to see. If this happens, use the viewfinder instead.

To Stop Recording . . .

.... press the Recording Start/Stop Button. The camcorder re-enters the Record-Standby mode.

Power Switch Position

- A** : Suitable for standard recording using NO special effects or manual adjustments.
- M** : Allows you to set recording functions using the menus for more creative capabilities.
- OFF** : Switches off the camcorder.
- PLAY** : Allows you to play back your recordings.

NOTES:

- If the Record-Standby mode continues for 5 minutes without performing Zoom or any other operations, the camcorder's power shuts off automatically. Set the Power Switch to "OFF", and then back to "A" or "M" to turn the camcorder on again.
- If you are recording on a cassette from the middle (such as when a tape is removed and re-inserted during recording), use the Retake function (pg. 21) to find the end of the last recording so you do not erase any of it.
- To remove the indications from the camcorder's display during recording, pg. 40, 42.

**JOURNALISTIC SHOOTING**

In some situations, different shooting angles may provide more dramatic results. Hold the camcorder in the desired position and tilt the LCD monitor in the most convenient direction. It can rotate 270° (90° downward, 180° upward).

SELF-RECORDING

You can shoot yourself while viewing your own image in the LCD monitor. Open the LCD monitor and tilt it upward 180° so that it faces forward, then point the lens toward yourself and start recording.

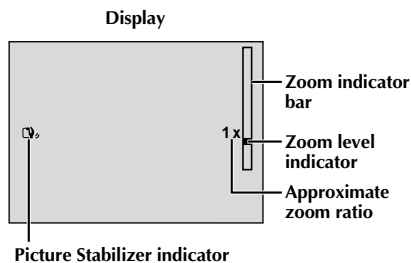
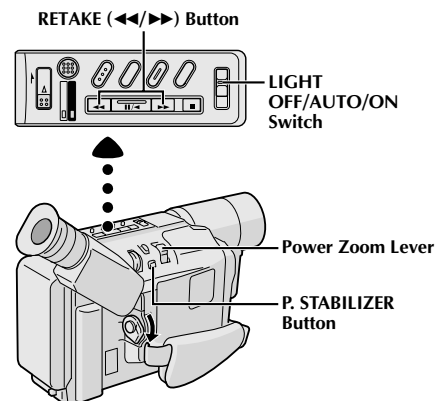
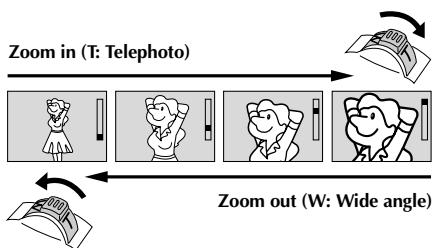

Zooming: To produce the zoom in/out effect, or an instantaneous change in image magnification.

Digital circuitry extends the maximum magnification offered by optical zoom. This system is called Digital Zoom.

Zoom In

Slide the Power Zoom Lever towards "T".

Zoom Out

Slide the Power Zoom Lever towards "W".

- The further you slide the Power Zoom Lever, the quicker the zoom action.
- Focusing may become unstable during Zooming. In this case, set the zoom while in Record-Standby, lock the focus by using the manual focus (☞ pg. 45), then zoom in or out in Record mode.
- The zoom level indicator (■) moves during zoom. Once the zoom level indicator reaches the top of the zoom indicator bar, all magnification from that point is through digital processing.
- When using Digital Zoom, the quality of image may suffer. To deactivate Digital Zoom, set "D.ZOOM" to "OFF" in SYSTEM MENU (☞ pg. 41).
- Digital zoom cannot be used when the "VIDEO ECHO" mode (☞ pg. 39) is activated (GR-SXM930 only).

Picture Stabilizer: To compensate for unstable images caused by camera-shake, particularly at high magnification.

- 1) Press **P. STABILIZER**. "📷" appears.
 - 2) To switch off the Picture Stabilizer, press **P. STABILIZER**. The indicator disappears.
- Accurate stabilization may not be possible if hand shake is excessive, or under the following conditions:
 - When shooting subjects with vertical or horizontal stripes.
 - When shooting dark or dim subjects.
 - When shooting subjects with excessive backlighting.
 - When shooting scenes with movement in various directions.
 - When shooting scenes with low-contrast backgrounds.
 - Switch off the Picture Stabilizer when recording with the camcorder on a tripod.
 - The "📷" indicator appears blinking if the Stabilizer cannot be used.
 - This function cannot be activated during the "Night-Alive" (☞ pg. 36), "CLASSIC FILM", "STROBE" and "VIDEO ECHO" mode (☞ pg. 39) (GR-SXM930 only).

Quick Review (for scenes recorded onto a tape):

To check the end of the last recording.

- 1) Make sure the camcorder is in the Record–Standby mode.
 - 2) Press ◀◀ and release quickly.
Tape is rewound for approx. 2 seconds and played back automatically, then pauses in Record–Standby mode for the next shot.
- *Distortion may occur at the start of playback. This is normal.*

Retake: To re-record certain segments.

- 1) Make sure the camcorder is in the Record–Standby mode.
 - 2) Press and hold either **RETAKE** to reach the start point for new recording. Pressing ▶▶ forwards the tape and pressing ◀◀ reverses it.
 - 3) Press the Recording Start/Stop Button to start recording.
- *Noise bars appear and pictures may become monochrome or darken during Retake. This is normal.*

Video Light: To brighten the scene when natural lighting is too dim.

1) Set **LIGHT OFF/AUTO/ON** as required:

OFF : Turns off the light.

AUTO : Automatically turns on the light when the camcorder senses insufficient lighting on the subject.

ON : Always keeps the light on as long as the camcorder is turned on.

- *The video light can only be used with the camcorder's power on.*
- *It is recommended to set the white balance (☞ pg. 46) to ☞ when you use the video light.*
- *When not using the video light, turn it off to save battery power.*
- *Even if the battery indicator (☐) does not blink if the battery pack's charge is low, the camcorder may turn off automatically when you turn on the video light turned on.*
- *When **LIGHT OFF/AUTO/ON** is set to "AUTO":*
 - *Depending on the lighting conditions, the video light may keep turning on and off. In this case, manually switch the light on or off using **LIGHT OFF/AUTO/ON**.*
 - *While the "Sports" or "High Speed Shutter" mode (☞ pg. 38) is engaged, the light is likely to stay on.*
 - *While the "Twilight" mode (☞ pg. 38) is engaged, the light will not activate.*



DANGER

- The video light can become extremely hot. Do not touch it either while in operation or soon after turning it off, otherwise serious injury may result.
- Do not place the camcorder into the carrying case immediately after using the video light, since it remains extremely hot for some time.
- When operating, keep a distance of about 30 cm (11-13/16") between the video light and people or objects.
- Do not use near flammable or explosive materials.
- It is recommended that you consult your nearest JVC dealer for replacing the video light.

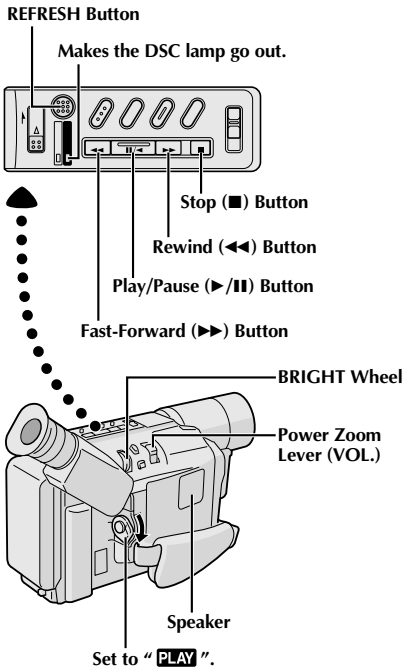

1 Load a tape (☞ pg. 15).

2 Set the Power Switch to “PLAY”. If the DSC Lamp is lit, press **REFRESH** for approx. 1 second to select “VIDEO”.

To start playback, press ▶/||.

• To stop playback, press ■.

• Press ◀◀ to rewind, or ▶▶ to fast-forward the tape during Stop mode.

NOTES:

- The camcorder shuts off automatically after about 5 minutes in Stop mode. To turn on again, set the Power Switch to “OFF”, then to “PLAY”.
- When the Power Switch is set to “PLAY” and the LCD monitor is opened at an angle of 60 degrees or more, the LCD monitor switches on and the viewfinder switches off automatically to save power.
- The playback picture can be viewed in the viewfinder (with the LCD monitor shut), on the LCD monitor or on a connected TV (☞ pg. 24, 25).
- You can also view the playback picture on the LCD monitor with it flipped over and retracted.
- If a blank portion on the tape is played back, the screen may become black. This is not a malfunction.

LCD Monitor Brightness Adjustment: Rotate the **BRIGHT** Wheel towards “+” to brighten, or towards “-” to darken.

- The Bright Level Indicator is displayed under the Date/Time Display when you play back images recorded in Wide Mode (☞ pg. 41).

Speaker Volume Control: Slide the Power Zoom Lever (**VOL.**) towards “+” to turn up the volume, or towards “-” to turn down the volume.

- The Speaker Volume Indicator is displayed under the Date/Time Display when you play back images recorded in Wide Mode (☞ pg. 41).

Still Playback: Pauses during playback.

1) Press ▶/|| during playback.

2) To resume normal playback, press ▶/|| again.

- Noise bars will appear and the picture will become monochrome during Still Playback.
- If TBC (☞ pg. 23) is engaged, noise bars will not appear. This mode is called Fine Still (GR-SXM930 only).

Shuttle Search: Allows high-speed search in either direction.

1) Press ▶▶ for forward or ◀◀ for reverse search during playback.

2) To resume normal playback, press ▶/||.

- During playback, press and hold ◀◀ or ▶▶. The search continues as long as you hold the button. Once you release it, normal playback resumes.
- Noise bars appear and pictures may become monochrome or darken during Shuttle Search. This is normal.

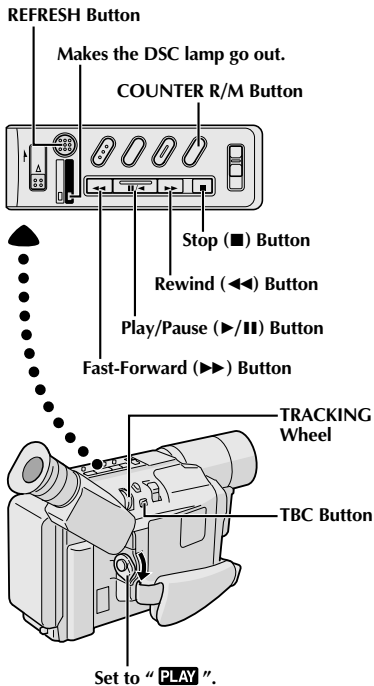

Tracking: Eliminates noise bars that appear on-screen during playback. Factory-preset is Auto Tracking. To activate Manual Tracking:

- 1) Press the **TRACKING** Wheel for approx. 2 seconds. "MT" appears.
 - 2) Rotate the **TRACKING** Wheel so that the noise bars disappear.
- To return to Auto Tracking, press the **TRACKING** Wheel for approx. 2 seconds or set the Power Switch to "OFF" and then "**PLAY**" again. "AT" blinks. When Auto Tracking finishes, the indication disappears.
 - When noise bars appear during playback, the camcorder enters the Auto Tracking mode and "AT" is displayed.
 - Manual Tracking may not work with tapes recorded on other VCRs or camcorders.

TBC (Time Base Corrector): Removes jitter from fluctuating video signals to deliver a stable picture even with old tapes. Factory-preset: TBC is engaged. To activate/release the TBC mode, press **TBC** during playback for more than 1 second. When the TBC mode is activated, "TBC" is displayed.

Counter Memory Function: Makes it easier to locate a specific tape segment.

- 1) Press **COUNTER R/M** and hold for more than 1 second. The counter resets to "0:00:00".
 - 2) Press **COUNTER R/M** for less than 1 second. "M" appears.
 - 3) After recording or playback, press ■, then ◀◀. The tape automatically stops at or close to 0:00:00.
 - 4) Press ▶/|| to start playback.
- The counter memory functions in the Fast-Forward and Rewind modes.
 - To disable the Counter Memory Function, press **COUNTER R/M** for less than 1 second so that "M" disappears.

Playback Special Effects (CLASSIC FILM, MONOTONE, SEPIA, STROBE and VIDEO ECHO,  pg. 39) (GR-SXM930 only):

Allows you to add creative effects to the playback image.

- 1) Activate the TBC mode and Auto Tracking.
 - 2) Press **DIGIFECT** repeatedly until the desired mode's name and indication appear. They are displayed for approx. 2 seconds, then the name disappears so that only the indication remains. The mode is activated.
 - 3) To cancel the effect, select "OFF" in step 2.
- Playback Special Effects do not work during shuttle search.
 - The selected effect mode cannot be changed during still playback.

Basic Connections

These are some basic types of connections. When making the connections, refer also to your VCR and TV instruction manuals.

A. Connection to a TV or VCR equipped with an S-VIDEO IN and A/V input connectors

Use optional S-Video and Audio cables.

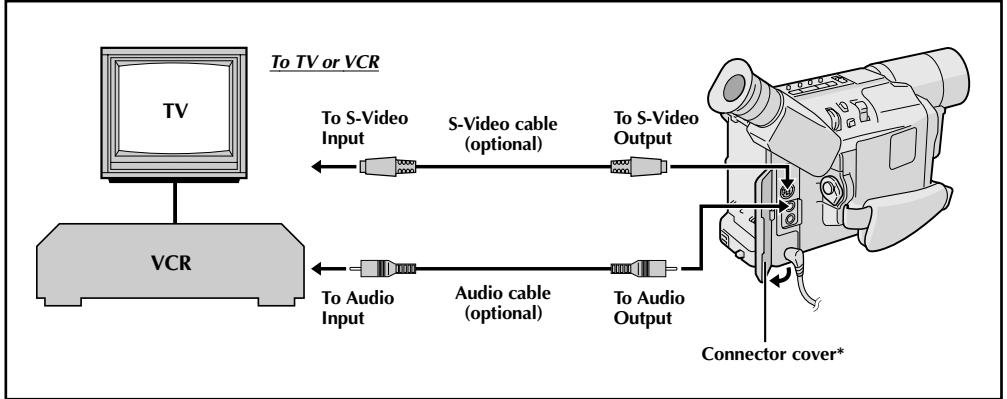

*When connecting the cables, open this cover.

B. Connection to a TV or VCR equipped only with A/V input connectors

Use optional Video and Audio cables.

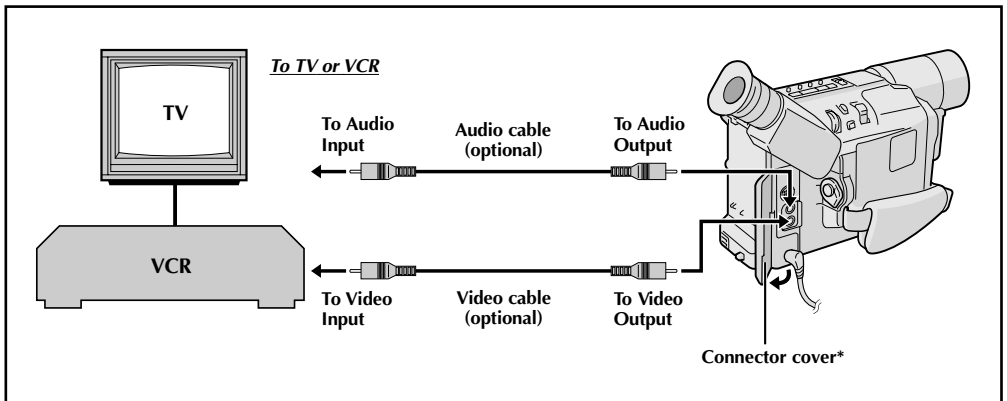

*When connecting the cables, open this cover.

Basic Connections

- 1** Make sure all units are turned off.

- 2** Connect the camcorder to a TV or VCR as shown in the illustration (☞ pg. 24).
If using a VCR . . . go to step 3.
If not . . . go to step 4.

- 3** Connect the VCR output to the TV input, referring to your VCR's instruction manual.

- 4** Turn on the camcorder, the VCR and the TV.

- 5** Set the VCR to its AUX input mode, and set the TV to its VIDEO mode.

NOTES:

- *It is recommended to use the AC Adapter as the power supply instead of the battery pack (☞ pg. 9).*
- *If your VCR has an S-Video input connector, connect the camcorder and the VCR using an optional S-Video cable. This can improve the dubbed picture quality.*
- *To monitor the picture and sound from the camcorder without inserting a tape, set the camcorder's Power Switch to "A" or "M", then set your TV to the appropriate input mode.*
- *Make sure you adjust the TV sound volume to its minimum level to avoid a sudden burst of sound when the camcorder is turned on.*
- *If you have a TV or speakers that are not specially shielded, do not place the speakers adjacent to the TV as interference will occur in the camcorder playback picture.*

Tape Dubbing

- 1** Following the illustration on pg. 24, connect the camcorder and the VCR.

- 2** Set the camcorder's Power Switch to "PLAY", turn on the VCR's power, and insert the appropriate cassettes in the camcorder and the VCR.

- 3** Engage the VCR's AUX and Record-Pause modes.

- 4** Engage the camcorder's Play mode to find a spot just before the edit-in point. Once it is reached, press ►/|| on the camcorder.

- 5** Press ►/|| on the camcorder and engage the VCR's Record mode.

- 6** Engage the VCR's Record-Pause mode and press ►/|| on the camcorder.

- 7** Repeat steps 4 through 6 for additional editing, then stop the VCR and camcorder when finished.

NOTE:

If you wish to dub still images recorded with the DSC Lamp lit, play back the still images (☞ pg. 30, 31), and instead of doing the above steps 4 through 6, engage the VCR's Record mode and record them onto a tape.

Using The Cassette Adapter (VHS Playpak)

Use this to play back an S-VHS-C/VHS-C video cassette recorded with this camcorder on a VHS VCR. It is fully compatible with any S-VHS/VHS video cassette recorder. The cassette adapter is battery powered and automatically performs tape loading and unloading.

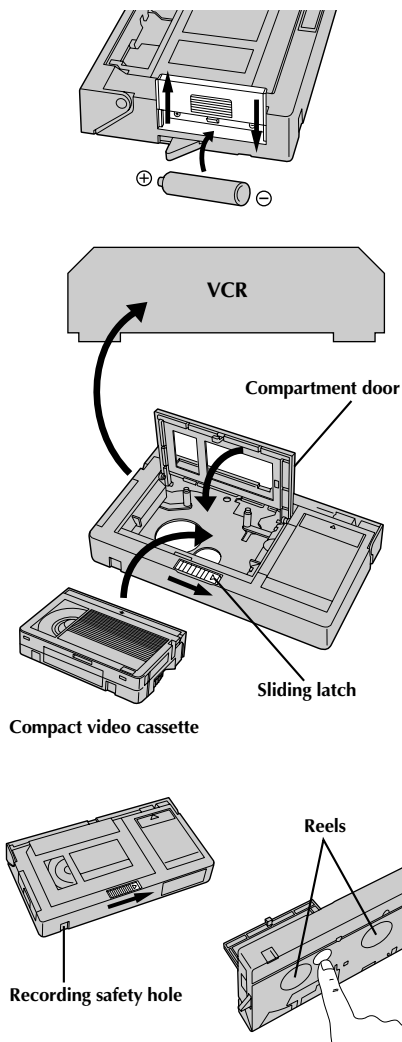

- 1** Slide the battery cover up to remove it, install one "AA (R6)" size battery as shown, then reattach the cover.
- 2** Slide the latch to open the adapter compartment door, then insert the cassette and close the compartment door.
- 3** Load the cassette adapter into the VCR and play the tape back as you would any other.
- 4** Slide the latch and the compartment door opens automatically. This may take around 10 seconds. Do not attempt to force the adapter open. Then, insert your finger in the hole on the underside of the adapter as shown in the illustration at left, and push up and remove the cassette.

NOTES:

- During tape loading and unloading, do not touch the reels for safety and tape protection.
- Tapes recorded in S-VHS or S-VHS ET mode cannot be played back on a regular VHS VCR. Playback is possible with a VCR equipped with the S-VHS or SQPB (S-VHS QUASI PLAYBACK) function.
- During special-effect playback (slow motion, still frame, etc.), the picture may vibrate or noise bars may appear on the screen.
- To record on a VCR using a compact cassette and the adapter, cover the adapter's recording safety hole with adhesive tape.

DIGITAL STILL CAMERA (D.S.C.) RECORDING & PLAYBACK

CONTENTS

D.S.C. RECORDING	28 – 29
Quick Review (for still images stored in the built-in memory)	29
D.S.C. PLAYBACK	30 – 34
Normal Playback	30
Slide Show	30
INDEX Screen	31
Index Playback	31
Protecting Images	32
Deleting Images	33
Connection To A Windows® PC	34

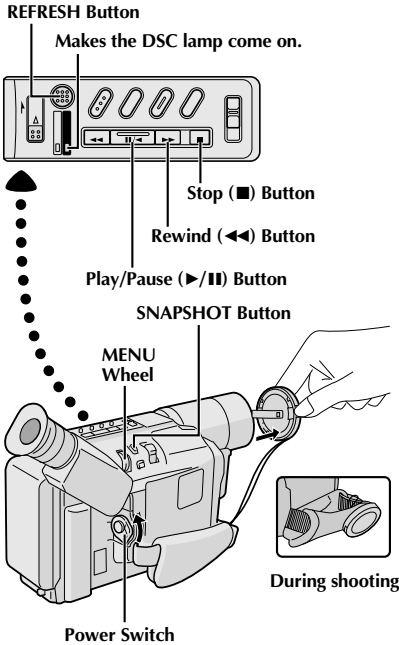

When shooting a still image, it is not recorded onto the tape, but it is stored in the camcorder's built-in memory in the selected Picture Mode. A stored still image data can be transferred to a PC, saved, and processed using a Paint Software program or Mr. Photo Gold (☞ pg. 34). A still image processed on the PC can be also inserted onto a tape (☞ pg. 53).

MODE SELECTION

- 1** Press in the tabs on the lens cap to remove it, then set the Power Switch to "M". The VIDEO Lamp comes on. If the DSC Lamp is not lit, press **REFRESH** for approx. 1 second to select "DSC". An image appears.
- 2** To select the Picture Mode, perform steps 2 through 4 of "Picture Mode Setting" on pg. 16.
- 3** Rotate the **MENU Wheel** to select "SNAPSHOT", and press it. The SNAPSHOT Menu appears. Rotate the **MENU Wheel** to select the appropriate mode among the 4 Snapshot modes (☞ pg. 29), and press it. Selection is complete.
- 4** The Menu Screen reappears with the highlight bar on "▶RETURN". Press the **MENU Wheel** in again to close the Menu Screen.

STILL IMAGE STORAGE

- 1** Press **SNAPSHOT**.
 - Regardless of the Power Switch position ("A" or "M"), Snapshot recording takes place using the selected Snapshot mode.
 - The remaining number of shots available is displayed.

To Delete Unwanted Still Images . . .

When the remaining number indicator displays "0" (blinking), it is not possible to continue storing pictures until you delete some shots to make room for new ones. Perform "DELETE" function in the Menu Screen to remove pictures you do not need (☞ pg. 33).

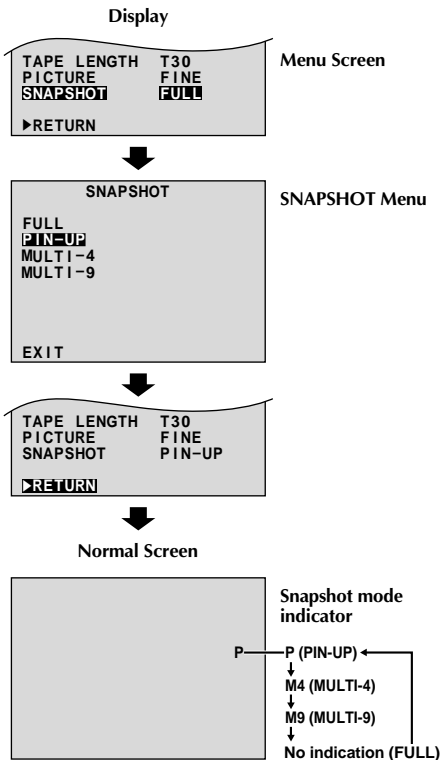

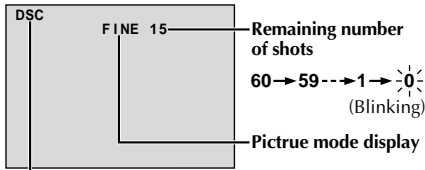

D.S.C. mode indicator

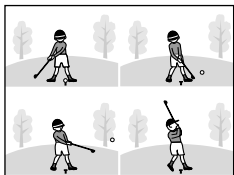
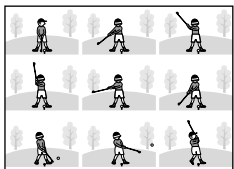
FULL*
(Snapshot mode with
no frame)PIN-UP*
(Pin-Up mode)MULTI-4**
(Multi-Analyzer 4)MULTI-9**
(Multi-Analyzer 9)**NOTES:**

- Some sample images have been stored in the built-in memory at the factory. If you wish to delete them, first remove the "Protecting Images" function (☞ pg. 32), then perform the "Deleting Images" function (☞ pg. 33).
- If a Snapshot is taken while the camcorder is in the WIDE mode (☞ pg. 41), the Snapshot image is recorded without the black bars at the top and bottom of the screen.
- When you shoot in a dark environment, the still image will become coarse and its true colors will be lost.
- During the D.S.C. recording, the Zooming (☞ pg. 20), Picture Stabilizer (☞ pg. 20) and Video Light (☞ pg. 21) functions can be operated.
- Still images are taken in a format based on JPEG (Joint Photographic Experts Group).
- When you use the LCD monitor outdoors under direct sunlight, the LCD monitor may be difficult to see. If this happens, close the LCD monitor and use the viewfinder instead.
- To store the still images you shot, we recommend that you transfer them to a computer and save them on disk (☞ pg. 34), or transfer them to a VCR connected to the camcorder and record them onto a tape.
- Image data stored in the camcorder's built-in memory can be transferred to a Windows® PC and saved using the provided image transfer software, Picture Navigator (☞ pg. 34).

* There is a momentary camera shutter-type blackout together with the image.

** Continuous camera shutter-type blackout takes place 4 or 9 times with the image, like serial photography, then the 4 or 9 still images you took are displayed.

Quick Review (for still images stored in the built-in memory):

To check the still image most recently stored in the built-in memory.

- 1) Set the Power Switch to "A" or "M". If the DSC Lamp is not lit, press **REFRESH** for approx. 1 second to select "DSC".
- 2) Press ◀ and release quickly.
 - The still image is displayed for approx. 3 seconds. The message "DELETE OK? PRESS PLAY BUTTON" appears.

To remove the still image you have checked (Instant Delete) . . .

Press ▶/II while the message "DELETE OK? PRESS PLAY BUTTON" is displayed.

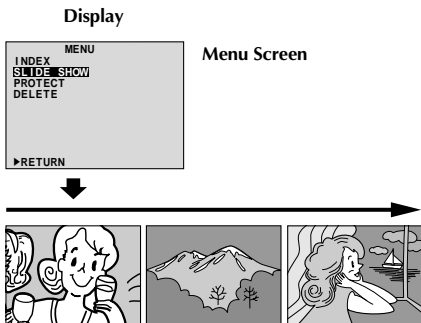
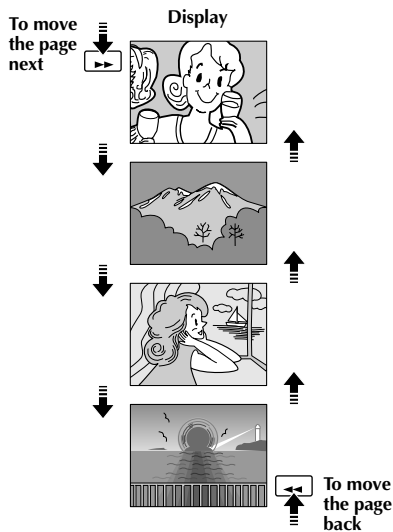
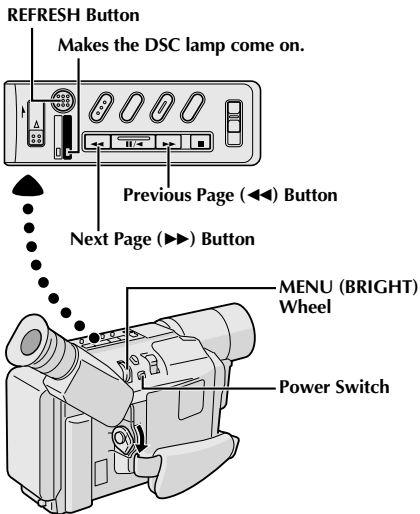

Normal Playback

Still images shot using this camcorder are automatically numbered, then stored in numerical order in the built-in memory. You can view the still images stored in memory, one at a time, much like flipping through a photo album.

- 1** Set the Power Switch to "**PLAY**". The VIDEO Lamp comes on. If the DSC Lamp is not lit, press **REFRESH** for approx. 1 second to select "DSC". A still image stored in memory is displayed.
 - When no still image is stored in memory, the screen becomes blue.
- 2** Press ▶ or ◀ to select the still image you want to view.
 - Each time ◀ is pressed, the page goes back, while each time ▶ is pressed, the page goes next.
 - If there are no stored images, "NO IMAGES STORED" is displayed.

NOTES:

- When the Power Switch is set to "**PLAY**" and the LCD monitor is opened at an angle of 60 degrees or more, the LCD monitor switches on and the viewfinder switches off automatically to save power.
- The playback picture can be viewed in the viewfinder (with the LCD monitor shut), on the LCD monitor or on a connected TV (see pg. 24).
- When viewing a playback picture on a connected TV, it may jitter slightly.
- You can also view the playback picture on the LCD monitor with it flipped over and retracted.
- To brighten the LCD monitor, rotate the **BRIGHT** Wheel towards "+". To darken the LCD monitor, rotate it towards "-".
- Even if you shoot a new picture after playing back a still image with a low number, this will not overwrite the existing picture because new pictures are automatically stored after the still image most recently stored in memory.

Slide Show

You can run through all the images stored in memory automatically in numerical order.

- 1** Set the Power Switch to "**PLAY**". If the DSC Lamp is not lit, press **REFRESH** for approx. 1 second to select "DSC".
- 2** Press the **MENU** Wheel in. The Menu Screen appears.
- 3** Rotate the **MENU** Wheel to select "SLIDE SHOW" and press it. The Slide Show starts.
- 4** To stop the Slide Show, press the **MENU** Wheel in twice.

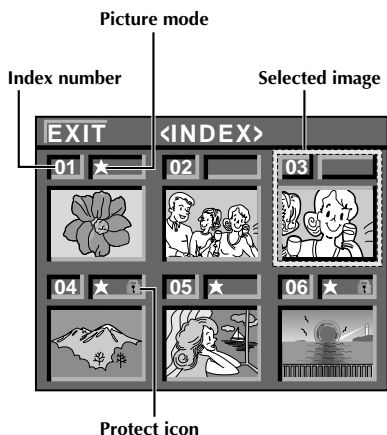

INDEX Screen

The images you shot can be displayed together with their index information. Convenient for checking images shot beforehand, the INDEX Screen also shows the Picture mode as well as which images are protected against accidental erasure.

01: Index number

Index numbers are marked from 01. For example, when 10 images are stored (index number: 01 to 10), if three images with index numbers 02, 04 and 06 are deleted from memory, the remaining images are automatically moved up to fill any gaps in the numerical sequence. Therefore, the number of remaining images is 7, and the new index numbers range from 01 to 07.

★: Picture mode

Displays the Picture mode of the stored image. There are 2 modes available: FINE and STANDARD (see pg. 16). A star mark is displayed next to still images shot in the FINE mode. There are no marks next to still images shot in the STANDARD mode.

🔒: Protect icon

When an image is protected against its accidental erasure, a padlock mark appears next to the Picture mode indicator, and that image cannot be deleted.

Selected Image

An image is framed like this when it is selected. Rotate MENU to move the frame to the desired image.

Index Playback

You can view all still images stored in memory six at a time. Use this mode when looking for a still image you want to view and when checking the still images you shot beforehand.

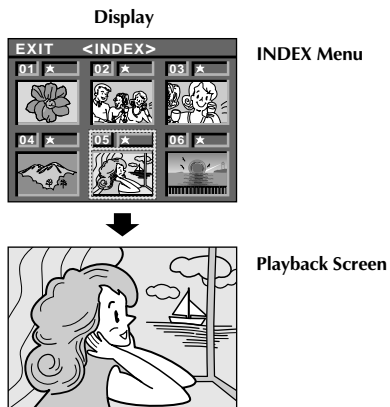

- 1 Set the Power Switch to "PLAY". If the DSC Lamp is not lit, press REFRESH for approx. 1 second to select "DSC".
- 2 Press the MENU Wheel in. The Menu Screen appears.
- 3 Rotate the MENU Wheel to select "INDEX" and press it. The INDEX Menu appears.
- 4 Rotate the MENU Wheel to select the desired still image, then press it. The one you selected is displayed on the whole screen, then the screen enters normal playback.
 - If the desired still image cannot be found, place the highlight bar on "EXIT", then press the MENU Wheel in twice to exit the menu.

NOTE:

On the Index Menu, a star mark is displayed next to a still image you shot in the FINE mode.

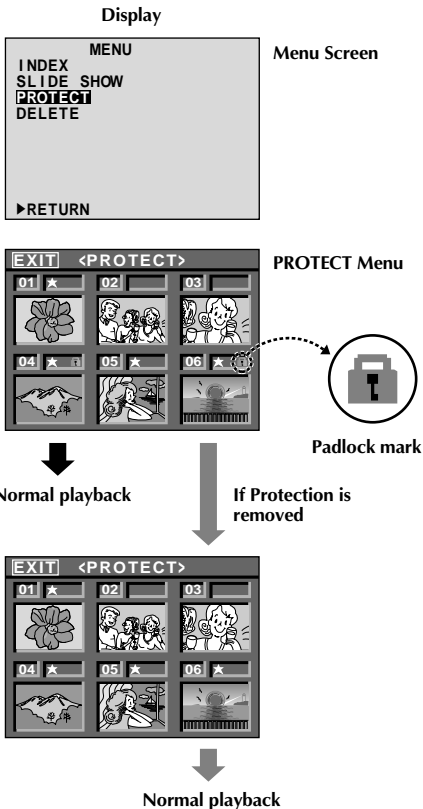
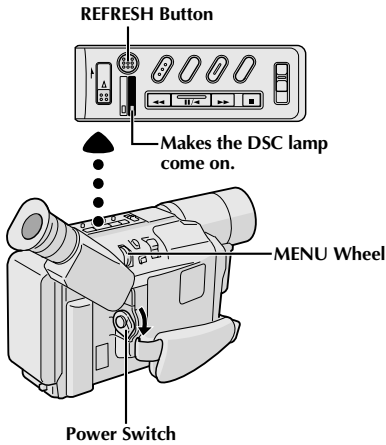

Protecting Images

The Protect mode helps prevent the accidental erasure of images. When a padlock mark is displayed next to the Picture Mode indication, that image cannot be deleted.

- 1** Set the Power Switch to "PLAY". If the DSC Lamp is not lit, press **REFRESH** for approx. 1 second to select "DSC".
- 2** Press the **MENU** Wheel in. The Menu Screen appears.
- 3** Rotate the **MENU** Wheel to select "PROTECT" and press it. The PROTECT Menu appears.

TO PROTECT AN IMAGE

Before doing the following, perform steps 1 through 3 above.

- 4** Rotate the **MENU** Wheel to move the frame to the desired image and press it. A "🔒" padlock mark appears on the selected image. Repeat this procedure for all images you do not wish to delete by accident.
- 5** Rotate the **MENU** Wheel upward to select "EXIT", then press it twice. The normal playback screen appears.

NOTE:

When the memory is initialized or corrupted, even protected images are deleted. If you do not want to lose important images, transfer them to a PC and save them.

TO REMOVE PROTECTION

Before doing the following, perform steps 1 through 3 above.

- 4** Rotate the **MENU** Wheel to move the frame to the desired image and press it. The "🔒" padlock mark located above the image disappears and the image is no longer protected. Repeat this procedure for all images from which you wish to remove protection.
- 5** Rotate the **MENU** Wheel upward to select "EXIT", then press it twice. The normal playback screen appears.

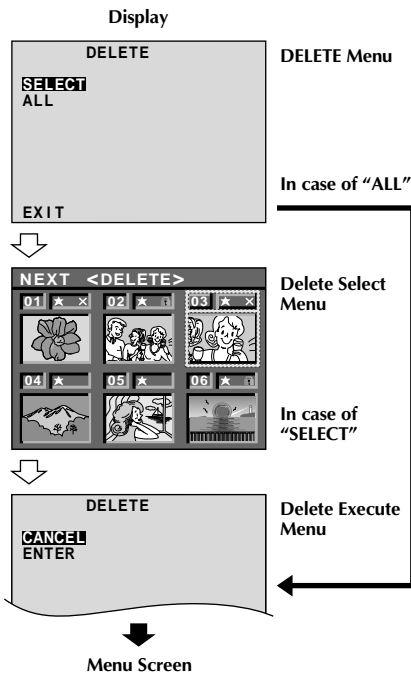
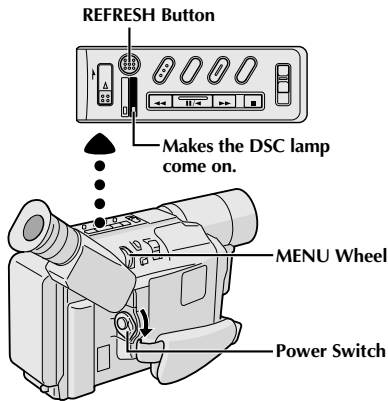

CAUTION:

While "ENTER" is selected on the Delete Execute Menu and it is blinking, switching off the camcorder or removing the power supply unit (battery pack or AC Adapter) may cause the camcorder's built-in memory to become corrupt. **Never remove the power supply unit at this stage.**

Deleting Images

Previously shot images can be deleted either one at a time or all at once.

- 1** Set the Power Switch to "PLAY". If the DSC Lamp is not lit, press **REFRESH** for approx. 1 second to select "DSC".
- 2** Press the **MENU** Wheel in. The Menu Screen appears.
- 3** Rotate the **MENU** Wheel to select "DELETE" and press it. The DELETE Menu appears.

TO SELECT AN IMAGE BY BROWSING IMAGES STORED IN MEMORY

Before doing the following, perform steps 1 through 3 above.

- 4** Rotate the **MENU** Wheel to select "SELECT" and press it. The Delete Select Menu appears.
- 5** Rotate the **MENU** Wheel to move the frame to the desired image that you wish to delete and press it. An "X" appears above the selected image. Repeat this procedure for all images that you wish to delete.
- 6** Rotate the **MENU** Wheel upward to select "NEXT" and press it. The Delete Execute Menu appears.
- 7** Rotate the **MENU** Wheel to select "ENTER" and press it. After "ENTER" blinks, the selected images are deleted and the Menu Screen reappears. Press the **MENU** Wheel in again to close the Menu Screen.
 - To cancel deletion, rotate the **MENU** Wheel to select "CANCEL" and press it twice. The Menu Screen closes.

TO DELETE ALL IMAGES

Before doing the following, perform steps 1 through 3 above.

- 4** Rotate the **MENU** Wheel to select "ALL" and press it. The Delete Execute Menu appears.
- 5** Rotate the **MENU** Wheel to select "ENTER" and press it. After "ENTER" blinks, all the images are deleted and the Menu Screen reappears. Press the **MENU** Wheel in again to close the Menu Screen.
 - To cancel deletion, rotate the **MENU** Wheel to select "CANCEL" and press it twice. The Menu Screen closes.

NOTES:

- Before deleting some still images stored in memory, perform "Protecting Images" for the necessary ones (pg. 32) or save them on a PC so that you do not lose them accidentally (pg. 34).
- Protected images (pg. 32) cannot be deleted with the above operation. To delete them, remove protection first.
- If the remaining number of shots is not 30 in the FINE mode or 60 in the STANDARD mode when "ALL" is selected on the DELETE Menu, initialize the camcorder's memory (pg. 57).

Makes the DSC lamp come on.

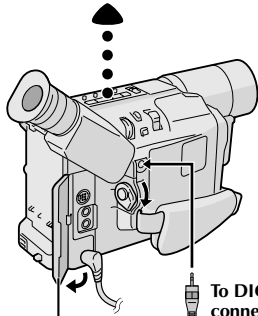
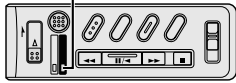

Open the cover.

To DIGITAL
connector

PC connection
cable*

For Windows®:
To COM Port
(RS-232C)

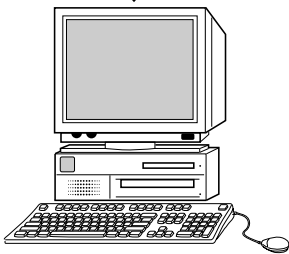

Connection To A Windows® PC

Image data stored in the camcorder's built-in memory can be transferred to a Windows® PC and saved using the image transfer software, Picture Navigator*. The image data transferred to a Windows® PC can also be further processed using Mr. Photo Gold*, and the still image processed on the PC can be inserted onto a tape (☞ pg. 53).

To assure safety, make sure all units are turned off before making any connection.

- 1** Connect the camcorder's DIGITAL connector to the COM Port (RS-232C) on a Windows® PC, using the PC connection cable*.
- 2** Set the Power Switch to "**PLAY**". The VIDEO Lamp comes on. If the DSC Lamp is not lit, press **REFRESH** for approx. 1 second to select "DSC". A still image stored in memory appears.
 - When transferring still images to a computer, be sure that a still image is displayed on the screen.
- 3** Launch the software* on your Windows® PC. Transfer the still images stored in the camcorder's memory to the Windows® PC. Refer to the software's instruction manual on the CD-ROM* for details.
 - During transfer of the still image, the camcorder's screen becomes blue and "**PC★MODE**" is displayed. After transferring is finished, the screen displays the same still image as in step 2.
- 4** Close the software*, then switch off the camcorder.

* Provided with GR-SXM930 only.

NOTES:

- Before transferring still images from your personal computer to the camcorder's built-in memory, perform the camcorder's Picture Mode Setting (☞ pg. 16). The still images will be transferred from the personal computer in the selected Picture Mode.
- When transferring still images from your personal computer to the camcorder, make sure the number of images to be transferred is smaller than the camcorder's remaining number of shots available.
- Use the AC Adapter as the power supply instead of the battery pack.
- The still images stored in the camcorder's memory are not automatically removed after being transferred to the PC. If you wish to remove those still images from the camcorder's memory, delete them (☞ pg. 33).
- Windows® are trademarks of Microsoft Corporation, registered in the U.S.A. and other countries.

ADVANCED FEATURES

CONTENTS

Night-Alive (GR-SXM930 only)	36
Fade/Wipe Effects	37
Program AE With Special Effects	38
Digital Effects	39
Using Menus For Detailed Adjustment	40 – 42
Snapshot	43
Exposure Control	44
Focusing	45
White Balance Adjustment	46
Manual White Balance Operation	46
Date/Time Insert	47
Instant Titles	47
Animation	48
Time-Lapse	48
USING THE REMOTE CONTROL UNIT	49 – 53
Installing The Batteries	50
Playback Zoom (GR-SXM930 only)	51
Animation And Time-Lapse	51
Insert Editing (VIDEO)	52
Insert Editing (Insert A Still Image From The Built-In Memory Onto A Tape) ...	53
Audio Dubbing	53

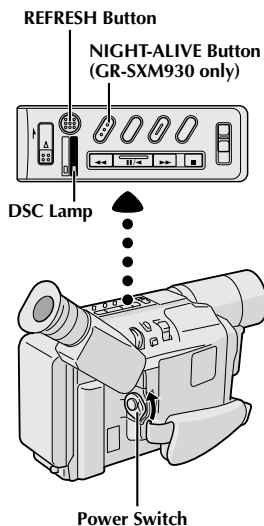

Night-Alive (GR-SXM930 only)

Makes dark subjects or areas even brighter than they would be under good natural lighting. Although the recorded image is not grainy, it may look as if it is strobing due to the slow shutter speed.

- 1** Set the Power Switch to “**A**” or “**M**”. Press **REFRESH** for approx. 1 second to select “**VIDEO**” (the DSC Lamp goes out) or “**DSC**” (the DSC Lamp comes on).
- 2** Press **NIGHT-ALIVE** repeatedly until the desired mode’s name and indication appear. They are displayed for approx. 2 seconds, then the name disappears so that only the indication remains. The mode is activated.
- 3** To cancel the effect, press **NIGHT-ALIVE** repeatedly until “**OFF**” appears. “**OFF**” is displayed for approx. 2 seconds.

A NIGHT AUTO

The shutter speed is automatically adjusted (maximum 1/5 sec.).

1 NIGHT 10X*

The shutter speed is set to 1/5th of a second to provide 10 times the sensitivity.

2 NIGHT 60X*

The shutter speed is set to 1 second to provide 60 times the sensitivity.

*Appears when the Power Switch is set to “**M**”.

NOTES:

- During Night-Alive, the following functions or settings cannot be activated:
 - “Picture Stabilizer” (☞ pg. 20), “Program AE With Special Effects” (☞ pg. 38) and “Digital Effects” (☞ pg. 39).
 - “S.LX” in CAMERA MENU (☞ pg. 41).
- Night-Alive does not work when **LIGHT OFF/AUTO/ON** is set to “**AUTO**” or “**ON**” (☞ pg. 21).
- During Night-Alive, it may be difficult to bring the camcorder into focus. To prevent this, use of a tripod is recommended.

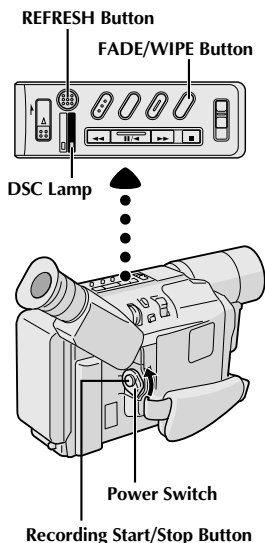

Fade/Wipe Effects

These effects let you make pro-style scene transitions. Fade- or wipe-in works at recording start, and fade- or wipe-out works at recording end.

- 1** Set the Power Switch to "M". If the DSC Lamp is lit, press **REFRESH** for approx. 1 second to select "VIDEO".
- 2** Press **FADE/WIPE** repeatedly until the desired mode's name and indication appear. They are displayed for approx. 2 seconds, then the name disappears so that only the indication remains. The effect is reserved.
- 3** Press the Recording Start/Stop Button to activate fade-in/out or wipe-in/out.
- 4** To cancel a fade or wipe, press **FADE/WIPE** repeatedly until "OFF" appears. "OFF" is displayed for approx. 2 seconds and the fade/wipe standby mode is canceled.

FADER

Fades in/out to a black screen.

MOSAIC (Fader)

Gradually turns/returns the picture into/from a mosaic pattern.

SHUTTER (Wipe)

A black screen moves in from the top and bottom, closing over the image like a shutter, or a new image pushes open the black screen vertically from the center.

SLIDE (Wipe)

A black screen moves in from the left to gradually cover the image, or a new image moves in from right to left.

DOOR (Wipe)

Wipes in as the two halves of a black screen open to the left and right, revealing the scene, or wipes out and the black screen reappears from left and right to cover the scene.

CORNER (Wipe)

Wipes in on a black screen from the upper right to the lower left corner, revealing the scene, or wipes out from lower left to upper right, leaving a black screen.

WINDOW (Wipe)

Wipes in on a black screen from the center of the screen towards the corners, revealing the scene, or wipe out from the corners to the center, leaving a black screen.

NOTE:

Pressing and holding the Recording Start/Stop Button allows you to vary the length for the image during fade in/out or wipe in/out.

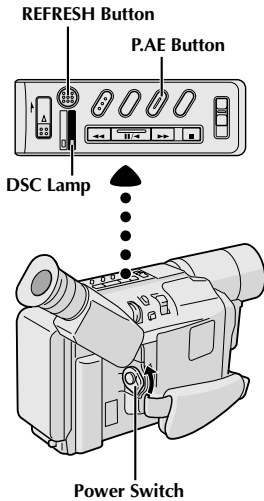

Program AE With Special Effects

- 1** Set the Power Switch to “**M**”. Press **REFRESH** for approx. 1 second to select “**VIDEO**” (the DSC Lamp goes out) or “**DSC**” (the DSC Lamp comes on).
- 2** Press **P.AE** repeatedly until the desired mode’s name and indication appear. They are displayed for approx. 2 seconds, then the name disappears so that only the indication remains. The mode is activated.
- 3** To cancel the effect, press **P.AE** repeatedly until “**OFF**” appears. “**OFF**” is displayed for approx. 2 seconds.

SPORTS

High shutter speed clearly captures fast-moving action.

ND : ND EFFECT

A black mist darkens the picture, as when an ND filter is used. Helps to counter the effects of glare on the subject.

FG : FOG

Makes the picture look misty white, as when an external fog filter is attached to the lens. Softens the image and gives it a “fantasy” look.

TWILIGHT

Dusk, twilight scenery, fireworks, etc., look more natural and dramatic. The following happens when Twilight mode is selected:

- Auto gain control is turned off.
- White Balance is set to “:FINE” (day mode), but can also be manually changed to another mode (☞ pg. 46).
- Auto Focus becomes available only in the range of 10 m (32 ft.) to infinity. To focus when the subject-to-camera distance is less than 10 m (32 ft.), use manual focusing (☞ pg. 45).

S1/2000 (1/2000 sec. High Speed Shutter)

Captures faster action than Sports mode.

NOTES:

- Only one mode can be engaged at a time.
- The screen becomes slightly dark in the High Speed Shutter mode. Use in well-lit situations.
- In the “High Speed Shutter” or “Sports” modes, picture color may be adversely affected if the subject is lit by alternating discharge-type light sources such as fluorescent or mercury-vapor lights.
- This function cannot be activated during Night-Alive (☞ pg. 36) (GR-SXM930 only).
- The “FOG” mode cannot be used when the “VIDEO ECHO” mode (☞ pg. 39) is activated (GR-SXM930 only).

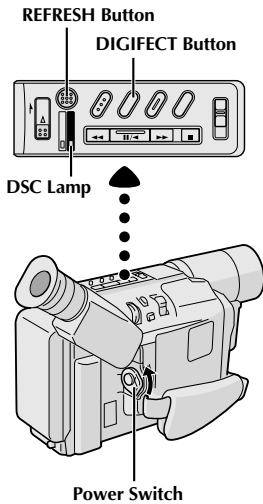

Digital Effects

- 1** Set the Power Switch to "M". Press **REFRESH** for approx. 1 second to select "VIDEO" (the DSC Lamp goes out) or "DSC" (the DSC Lamp comes on).
- 2** Press **DIGIFECT** repeatedly until the desired mode's name and indication appear. They are displayed for approx. 2 seconds, then the name disappears so that only the indication remains. The mode is activated.
- 3** To cancel the effect, press **DIGIFECT** repeatedly until "OFF" appears. "OFF" is displayed for approx. 2 seconds.

SEPIA

Recorded scenes have a brownish tint like old photos. Combine this with the WIDE mode (pg. 40, 41) for a classic look.

B/W MONOTONE

Like black and white films, your footage is shot in B/W. Combine this with the WIDE mode (pg. 40, 41) for a classic look.

NEGA POSI

The colors of a picture are reversed.

MOSAIC

Turns recorded scenes into a mosaic pattern.

STRETCH

Doubles the width of the picture horizontally.

CLASSIC FILM*

Makes your footage look like a classic movie by shooting in black and white, with a strobing effect, and black bars added at the top and bottom.

STROBE*

Your recording looks like a series of consecutive snapshots.

VIDEO ECHO*

Adds a "ghost" to the subject, giving your recording a "fantasy" feeling. Zoom magnification of over 10X is not available.

*GR-SXM930 only.

NOTES:

- *Digital Effects can be changed during recording or during Record-Standby.*
- *Digital zoom (pg. 20) cannot be used when the "VIDEO ECHO" mode is activated (GR-SXM930 only).*
- *This function cannot be activated during the Night-Alive (pg. 36) (GR-SXM930 only).*
- *Picture Stabilizer (pg. 20) cannot be activated during the "CLASSIC FILM", "STROBE" and "VIDEO ECHO" mode (GR-SXM930 only).*

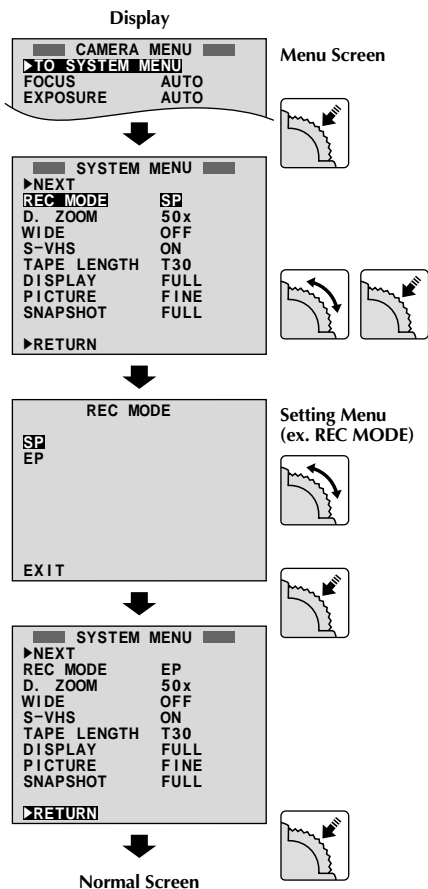
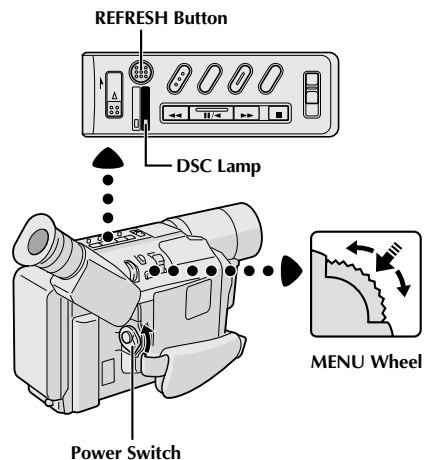

Using Menus For Detailed Adjustment

This camcorder is equipped with an easy-to-use, on-screen menu system that simplifies many of the more detailed camcorder settings.

- 1** The operation system depends on the function you wish to select.
Set the Power Switch to "M". Press **REFRESH** for approx. 1 second to select "VIDEO" (the DSC Lamp goes out) or "DSC" (the DSC Lamp comes on) according to each function's "*"/** explanation described at the bottom of pages 41 and 42.
- 2** Press the **MENU** Wheel in. The Menu Screen appears.
- 3** Rotate the **MENU** Wheel to select the desired function.
 - To go from CAMERA MENU to SYSTEM MENU, rotate the **MENU** Wheel to select "▶ TO SYSTEM MENU" and press it. SYSTEM MENU is composed of 2 pages. To go to the next page, rotate the **MENU** Wheel to select "▶ NEXT" and press it.
 - To return to CAMERA MENU from page 2 of SYSTEM MENU, rotate the **MENU** Wheel to select "▶ TO CAMERA MENU" and press it.
- 4** Press the **MENU** Wheel in to display the Setting Menu and rotate it to select the desired setting.
- 5** Press the **MENU** Wheel in. The Menu Screen reappears with the highlight bar on "▶ RETURN".
- 6** Press the **MENU** Wheel in. The normal screen reappears.

MENU SCREEN EXPLANATIONS

CAMERA MENU

FOCUS	Refer to “Focusing” (☞ pg. 45).	
EXPOSURE	Refer to “Exposure Control” (☞ pg. 44).	
M.W.B.	Refer to “White Balance Adjustment” and “Manual White Balance Operation” (☞ pg. 46).	
S.LX	MAX	To record a subject in a darkly lit environment, when it is more convenient to shoot the subject with a brighter image even if the picture becomes slightly coarse.
	NORMAL	To record a subject in a dimly lit environment, when it is more convenient to shoot with a less coarse picture although the subject becomes slightly dark. This setting is suitable for measuring sensitivity conforming to EIA-639 (EIA* Standard for Low Light Sensitivity Measurement). *EIA : Electronic Industries Alliance
	OFF	Allows you to shoot dark scenes with no picture brightness adjustment.
TITLE*	Allows you to superimpose one of eight preset titles (☞ pg. 47).	
DATE/TIME DISP.*	Makes the date/time settings appear in the camcorder or on a connected monitor (☞ pg. 47).	

SYSTEM MENU

This Menu Screen cannot be accessed while recording.

REC MODE*	Allows you to set the recording mode (SP or EP) depending on your preference (☞ pg. 14).	
D. ZOOM	50X	Allows you to use the Digital Zoom. By digitally processing and magnifying images, zooming is possible from 16X (the optical zoom limit), to a maximum of 50X digital magnification.
	400X	Allows you to use the Digital Zoom. By digitally processing and magnifying images, zooming is possible from 16X (the optical zoom limit), to a maximum of 400X digital magnification.
	OFF	Digital Zoom is not available. Only optical zoom (maximum 16x magnification) can function. When set to “OFF” during Digital Zoom, zoom magnification changes to 16X.
WIDE	OFF	Does not display black bars.
	ON	Allows you to record black bars at the top and bottom of the screen to produce a cinema-like “wide-screen” effect. If a snapshot (☞ pg. 28, 43) is taken while the camcorder is in the WIDE mode, the snapshot image is recorded without the black bars at the top and bottom of the screen.

* Activated only when “VIDEO” is selected (the DSC Lamp is not lit). If “DSC” is selected (the DSC Lamp is lit), this function will not be activated even though the highlight bar on the Menu Screen will move to that position.

Functions listed without an asterisk are available when either “DSC” or “VIDEO” is selected.

: Factory-preset

CONTINUED ON NEXT PAGE

SYSTEM MENU (cont.)

S-VHS*** (S-VHS ET***)	ON	Records in S-VHS on a VHS or S-VHS cassette (☞ pg. 12).
	OFF	Records in VHS on a VHS or S-VHS cassette (☞ pg. 12).
TAPE LENGTH*	Allows you to set the tape length depending on the tape used (☞ pg. 14).	
DISPLAY	FULL	Make all of the indications appear on the LCD monitor/viewfinder during playback or recording.
	SIMPLE	Make the following indications disappear from the LCD monitor/viewfinder during recording or playback: cassette warning, tape remaining time, battery pack remaining power indicator and tape length indicator (☞ pg. 62, 63)
PICTURE**	Refer to "Picture Mode Setting" (☞ pg. 16).	
SNAPSHOT	FULL	Displayed when "VIDEO" (the DSC Lamp is not lit, ☞ pg. 43) or "DSC" (the DSC Lamp is lit, ☞ pg. 29) is selected.
	PIN-UP	
	MULTI-4	Displayed when "DSC" (the DSC Lamp is lit, ☞ pg. 29) is selected.
	MULTI-9	
REC TIME*	Refer to "Animation" and "Time-Lapse" (☞ pg. 48).	
INT. TIME	Refer to "Time-Lapse" (☞ pg. 48).	
TELE MACRO	OFF	Usually the distance to a subject where the lens is in focus depends on the zoom magnification. Unless there is a distance of more than 1 m (3.25 ft) to the subject, the lens is out of focus at the maximum telephoto setting. When set to "ON", you can shoot a subject as large as possible at a distance of approx. 60 cm (23-5/8"). • Depending on the zoom position, the lens may go out of focus.
	ON	
TITLE LANG.*	Allows you to select the language (ENGLISH, FRENCH, SPANISH or PORTUGUESE) of Instant Titles (☞ pg. 47).	
DATE/TIME	Allows you to set the current date and time (☞ pg. 11).	
DEMO MODE*	ON	Demonstrates certain functions automatically. When "DEMO MODE" is set to "ON" and the Menu Screen is closed, the demonstration starts. Operating the Power Zoom Lever during the demonstration stops the demonstration temporarily. If the Power Zoom Lever is not moved for more than 1 minute after that, the demonstration will resume. NOTE: <i>When a tape whose Erase Protection tab is in the position that allows recording is loaded in the camcorder, demonstration is not available.</i>
	OFF	Automatic demonstration will not take place.

* Activated only when "VIDEO" is selected (the DSC Lamp is not lit). If "DSC" is selected (the DSC Lamp is lit), this function will not be activated even though the highlight bar on the Menu Screen will move to that position.

** Activated only when "DSC" is selected (the DSC Lamp is lit). If "VIDEO" is selected (the DSC Lamp is not lit), this function will not be activated even though the highlight bar on the Menu Screen will move to that position.

Functions listed without */** are available when either "DSC" or "VIDEO" is selected.

*** S-VHS ET is displayed when a VHS cassette is loaded, and S-VHS is displayed when an S-VHS cassette is loaded (☞ pg. 12). If a cassette is not loaded, "S-VHS" will be displayed in the Menu Screen. S-VHS ET is preset to "OFF".

: Factory-preset

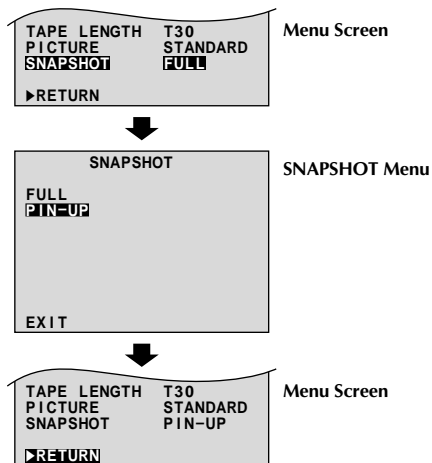
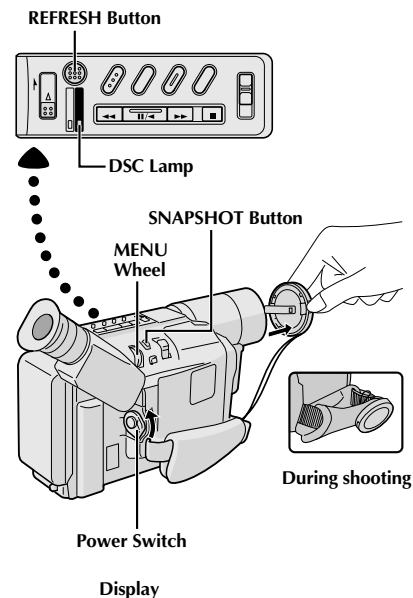

FULL
(Snapshot mode with
no frame)



PIN-UP
(Pin-Up mode)

Snapshot

This interesting feature lets you record two types of digital still images that look like photographs onto a tape, as well as keeping them in the camcorder's built-in memory. It is a great way to spice up footage of events such as parties, weddings and graduations.

SNAPSHOT MODE SELECTION

- 1** Press in the tabs on the lens cap to remove it, then set the Power Switch to "M". The VIDEO Lamp comes on. If the DSC Lamp is lit, press **REFRESH** for approx. 1 second to select "VIDEO". The camcorder enters Record-Standby mode.
- 2** Press the **MENU** Wheel in. The Menu Screen appears.
- 3** Rotate the **MENU** Wheel to select "▶ TO SYSTEM MENU" and press it to display SYSTEM MENU.
- 4** Rotate the **MENU** Wheel to select "SNAPSHOT", and press it. The SNAPSHOT Menu appears. Rotate the **MENU** Wheel to select "FULL" or "PIN-UP", and press it. Selection is complete.
- 5** The Menu Screen reappears with the highlight bar on "▶ RETURN". Press the **MENU** Wheel in to close the Menu Screen.

SNAPSHOT RECORDING

- 1** Press **SNAPSHOT**.
 - Regardless of the Power Switch position ("A" or "M"), Snapshot recording takes place using the selected Snapshot mode.

If you press during Record-Standby . . .

.... a still image will be recorded for approx. 6 seconds, then the camcorder re-enters the Record-Standby mode.

If you press during Recording . . .

.... a still image will be recorded for approx. 6 seconds, then the normal recording resumes.

NOTES:

- When the remaining number indicator displays "0" (blinking), the still image will be recorded onto the tape but not in the built-in memory. If you wish to store a still image in the built-in memory, see pg. 33.
- If a snapshot is taken while the camcorder is in the WIDE mode (see pg. 41), the snapshot image is recorded without the black bars at the top and bottom of the screen.
- When a Snapshot is taken in a dark environment, the still image recorded onto the tape and stored in memory will become coarse and its true colors will be lost.
- The Snapshot mode can also be used during playback. However, only the Full mode is available regardless of the Snapshot mode setting, and the shutter sound is not heard.

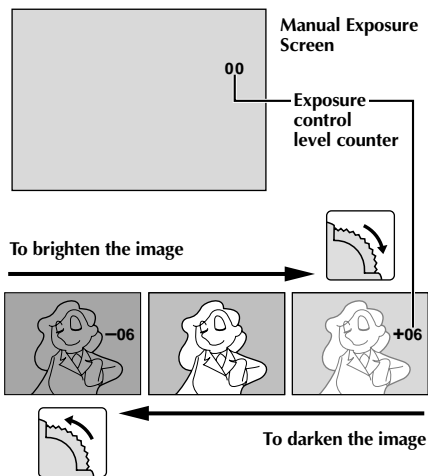
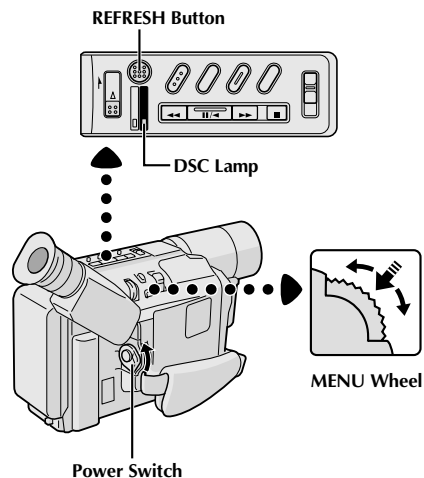

Exposure Control

This feature automatically adjusts the iris for the best available picture quality, but you can override it and make the adjustment manually. Manual exposure adjustment is recommended in the following situations:

- When shooting using reverse lighting or when the background is too bright.
- When shooting on a reflective natural background such as at the beach or when skiing.
- When the background is overly dark or the subject light.

- 1 Set the Power Switch to "M". Press **REFRESH** for approx. 1 second to select "VIDEO" (the DSC Lamp goes out) or "DSC" (the DSC Lamp comes on).
- 2 Press the **MENU** Wheel in. The Menu Screen appears.
- 3 Rotate the **MENU** Wheel to select "EXPOSURE" and press it. The EXPOSURE Menu appears.
- 4 Rotate the **MENU** Wheel to select "MANU", then press it. The Menu Screen disappears and "00" (exposure control level counter) appears.
- 5 To brighten the image, rotate the **MENU** Wheel downward. The exposure control level counter increases (maximum +06). To darken the image, rotate the **MENU** Wheel upward. The exposure control level counter decreases (maximum -06).
- 6 Press the **MENU** Wheel in. The setting is complete. The Menu Screen reappears with the highlight bar on "RETURN".
- 7 Press the **MENU** Wheel in. The Menu Screen disappears and the exposure control level counter reappears to indicate the exposure is adjusted.

NOTES:

- To return to the factory setting, select "AUTO" in step 4.
- To re-adjust exposure, repeat the procedure from step 2.

Focus detection zone

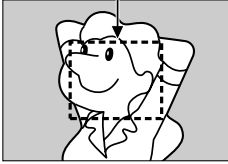
**NOTES:**

- If the lens is smeared or blurred, accurate focusing is not possible. Keep the lens clean, wiping with a piece of soft cloth if it gets dirty. When condensation occurs, wipe with a soft cloth or wait for it to dry naturally.
- When shooting a subject close to the lens, zoom out first (☞ pg. 20). If zoomed in in the auto focus mode, the camcorder could automatically zoom out depending on the distance between the camcorder and the subject. This does not occur with "TELE MACRO" (☞ pg. 42).

REFRESH Button

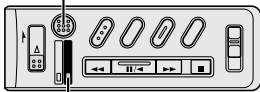

DSC Lamp

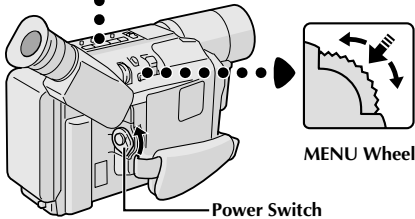

MENU Wheel

Power Switch

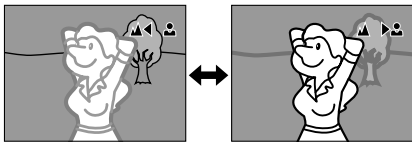
**Focusing****AUTO FOCUS**

The camcorder's Full Range AF system offers continuous shooting ability from close-up to infinity. However, correct focus may not be obtainable in the situations listed below (in these cases use manual focusing):

- When two subjects overlap in the same scene.
- When illumination is low.*
- When the subject has no contrast (difference in brightness and darkness), such as a flat, one-color wall, or a clear, blue sky.*
- When a dark object is barely visible in the viewfinder.*
- When the scene contains minute patterns or identical patterns that are regularly repeated.
- When the scene is affected by sunbeams or light reflecting off the surface of a body of water.
- When shooting a scene with a high-contrast background.

* The low-contrast warning "▲▲" appears.

MANUAL FOCUS

Make the necessary viewfinder adjustments to use the viewfinder (☞ pg. 10).

- 1 Set the Power Switch to "M". Press **REFRESH** for approx. 1 second to select "VIDEO" (the DSC Lamp goes out) or "DSC" (the DSC Lamp comes on).
- 2 Press the **MENU** Wheel in. The Menu Screen appears.
- 3 Rotate the **MENU** Wheel to select "FOCUS" and press it. The FOCUS Menu appears.
- 4 Rotate the **MENU** Wheel to select "MANU", then press it. The Menu Screen disappears and "▲" and "▲" appear. The focus is locked at this point.
- 5 To focus on a farther subject, rotate the **MENU** Wheel upward. "◀" appears and blinks.
To focus on a nearer subject, rotate the **MENU** Wheel downward. "▶" appears and blinks.
- 6 Press the **MENU** Wheel in. The setting is complete. The Menu Screen reappears with the highlight bar on "▶RETURN".
- 7 Press the **MENU** Wheel in. The Menu Screen disappears and "▲▲" reappears to indicate the focus is locked.

NOTES:

- To return to Auto Focus, select "AUTO" in step 4.
- To re-adjust Manual Focus, repeat the procedure from step 2.
- Be sure to focus the lens in the maximum telephoto position when you use the Manual Focus mode. If you focus in on a certain subject in the wide-angle position, sharply focused images cannot be obtained when zoomed in because the depth-of-field is reduced at longer focal lengths.
- When the focus level cannot be adjusted any farther or closer, "▲" or "▲" will blink.

White Balance Adjustment

A term that refers to the correctness of color reproduction under various lighting. If the white balance is correct, all other colors will be accurately reproduced.

The white balance is usually adjusted automatically. However, more advanced camcorder operators control this function manually to achieve a more professional color/tint reproduction.

- 1** Set the Power Switch to "M". Press **REFRESH** for approx. 1 second to select "VIDEO" (the DSC Lamp goes out) or "DSC" (the DSC Lamp comes on).
- 2** Press the **MENU** Wheel in. The Menu Screen appears.
- 3** Rotate the **MENU** Wheel to select "M.W.B.", then press it. The M.W.B. Menu appears.
- 4** Rotate the **MENU** Wheel to select the desired setting.
 - "AUTO"
White balance is adjusted automatically (factory preset).
 - "☀️" : **FINE**
Outdoors on a sunny day.
 - "☁️" : **CLOUD**
Outdoors on a cloudy day.
 - "💡" : **HALOGEN**
A video light or similar type of lighting is used.
 - "MWB"
White balance is set manually.
- 5** Press the **MENU** Wheel in. The Menu Screen reappears with the highlight bar on "▶ RETURN". Press the **MENU** Wheel in again to close the Menu Screen.

To Return To Automatic White Balance . . .

.... select "AUTO" in step 4. Or set the Power Switch to "A".

NOTE:

White balance cannot be used when the "SEPIA" or "MONOTONE" mode (☞ pg. 39) is activated.

Manual White Balance Operation

Perform Manual White Balance when shooting under various types of lighting.

- 1** Follow steps 1 through 4 of the white balance adjustment, and select "MWB".
- 2** Hold a sheet of plain white paper in front of the subject. Adjust zoom or position yourself so that the white paper fills the screen.
- 3** Press the **MENU** Wheel in until "MWB" begins blinking. When the setting is completed, "MWB" stops blinking, and the Menu Screen reappears with the highlight bar on "▶ RETURN".
- 4** Press the **MENU** Wheel in again to close the Menu Screen.

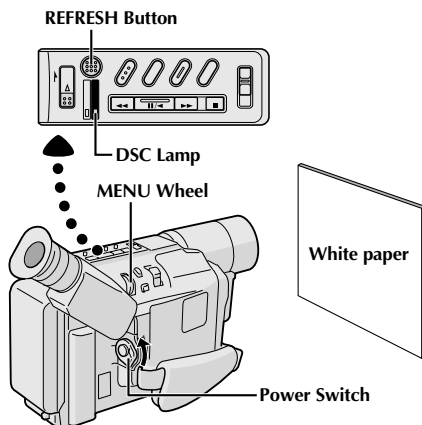

To Change The Tint For Recording . . .

.... in step 2, substitute colored paper for white. The white balance is adjusted based on the color, changing the tint. Red paper = deeper green; blue paper = orange; yellow paper = deeper purple.

NOTES:

- In step 2, it may be difficult to focus on the white paper. In such a case, adjust focus manually (☞ pg. 45).
- A subject can be shot under various types of lighting conditions indoors (natural, fluorescent, candlelight, etc.). Because the color temperature is different depending on the light source, the subject tint will differ depending on the white balance settings. Use this function for a more natural result.
- Once you adjust white balance manually, the setting is retained even if the power is turned off or the battery removed.

Date/Time Insert

Allows you to display the date and time in the camcorder or on a connected color monitor, as well as to record them manually or automatically.

You should have already performed the Date/Time Setting procedure (☞ pg. 11).

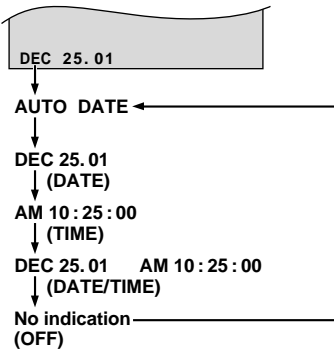
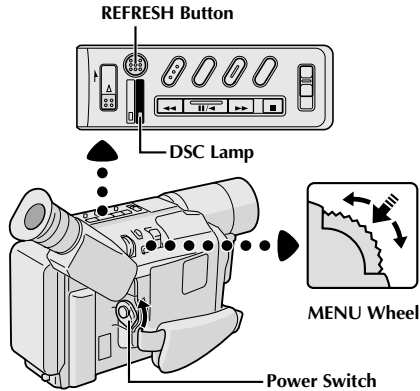

Instant Titles

The camcorder has eight preset titles in memory. You can superimpose one of them over the video image.

Instant Titles can be displayed not only in English but also in French, Spanish and Portuguese. Change the setting in TITLE LANG. in SYSTEM MENU (☞ pg. 42).

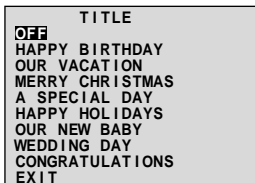

- 1 Set the Power Switch to "M". If the DSC Lamp is lit, press **REFRESH** for approx. 1 second to select "VIDEO".
- 2 Press the **MENU** Wheel in. The Menu Screen appears.
- 3 Rotate the **MENU** Wheel to select "DATE/TIME DISP." and press it. The DATE/TIME DISP. Menu appears.
- 4 Rotate the **MENU** Wheel to select the desired mode, then press it. The desired mode is activated.
- 5 The Menu Screen reappears with the highlight bar on "▶ RETURN". Press the **MENU** Wheel in to close the Menu Screen.

NOTES:

DISPLAY

- The selected display can be recorded.
- If you do not want to record the display, select the OFF mode before shooting.
- The date/time is displayed during the VIDEO mode only, and it is recorded only onto the tape.

AUTO DATE

- Your camcorder automatically records the date for about 5 seconds after recording is initiated in the following situations:
 - After changing the date.
 - After loading a cassette.
 - After Auto Date Record mode is selected by rotating the **MENU** Wheel.
- In this mode, the date is replaced after 5 seconds with "AUTO DATE" but this is not recorded.

- 1 Set the Power Switch to "M". If the DSC Lamp is lit, press **REFRESH** for approx. 1 second to select "VIDEO".
- 2 Press the **MENU** Wheel in. The Menu Screen appears.
- 3 Rotate the **MENU** Wheel to select "TITLE" and press it. The TITLE Menu appears.
- 4 Rotate the **MENU** Wheel to select the desired mode, then press it. The desired mode is activated.
- 5 The Menu Screen reappears with the highlight bar on "▶ RETURN". Press the **MENU** Wheel in to close the Menu Screen.

NOTES:

- The title is displayed during the VIDEO mode only, and it is recorded only onto the tape.
- The selected title will remain until OFF is selected in the TITLE Menu.

NOTE:

Before performing the following steps, make sure that:

- "VIDEO" is selected (the DSC Lamp is not lit).
- The Power Switch is set to "M".
- The camcorder is in the Record-Standby mode.
- The recording mode is set to "SP".

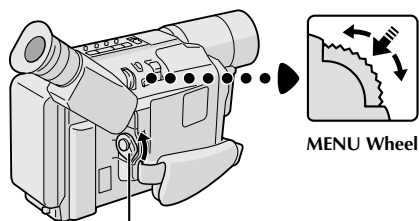

Recording Start/Stop Button

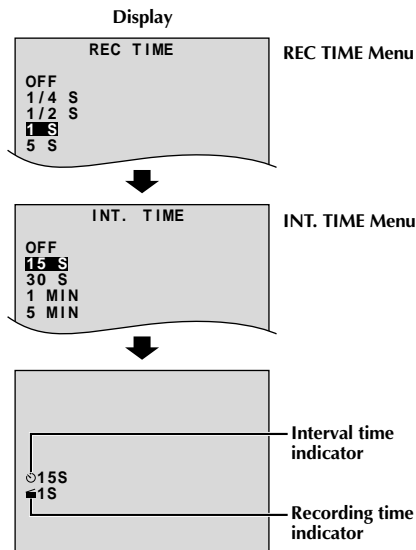
**Animation**

You can shoot a series of pictures, each slightly different, of the same object for a brief period of time.

- 1 Press the **MENU** Wheel in. The Menu Screen appears.
- 2 Rotate the **MENU** Wheel to select "▶ TO SYSTEM MENU" and press it to display SYSTEM MENU. Rotate the **MENU** Wheel to select "▶ NEXT" and press it to display the next page. Then, rotate the **MENU** Wheel to select "REC TIME" and press it. The REC TIME Menu appears. Rotate the **MENU** Wheel to select the desired recording time, then press it.
- 3 The Menu Screen reappears with the highlight bar on "▶ RETURN". Press the **MENU** Wheel in again to close the Menu Screen.
- 4 Press the Recording Start/Stop Button after focusing on the subject. The recording stops automatically after the selected period of time.
 - Repeat step 4 for the desired number of pictures.
- 5 To release the Animation mode, set "REC TIME" in the Menu screen to "OFF".

Time-Lapse

You can record sequentially at preset time spans. Leaving the camcorder aimed at a specific subject, you can record subtle changes over an extended period of time.

- 1 Set "REC TIME" (☞ step 1 and 2 of "Animation" above).
- 2 Rotate the **MENU** Wheel to select "INT. TIME" and press it. The INT. TIME Menu appears. Rotate the **MENU** Wheel to select the desired interval time, then press it. The Menu Screen reappears with the highlight bar on "▶ RETURN". Press the **MENU** Wheel in again to close the Menu Screen.
- 3 Press the Recording Start/Stop Button. Recording and intervals alternate automatically.
- 4 To release the Time-Lapse mode, when "REC" is not displayed, press the Recording Start/Stop Button to display "≡ PAUSE ≡", then set "REC TIME" and "INT. TIME" in the Menu Screen to "OFF".

NOTES (for Animation and Time-Lapse):

- For best results, make sure the camcorder is secured when shooting in Animation or Time-Lapse mode.
- Fade- or wipe-in/out cannot be performed during Animation or Time-Lapse shooting.
- Before performing other operations following Animation or Time-Lapse recording, make sure the Animation or Time-Lapse mode is deactivated.
- Animation and Time-Lapse are canceled when the power is shut off or when the cassette is ejected.

The Full-Function Remote Control Unit can operate this camcorder from a distance as well as the basic operations (Playback, Stop, Pause, Fast-Forward and Rewind) of your VCR.

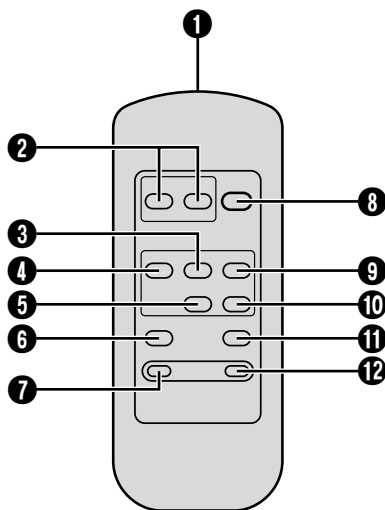

Buttons	Functions	
	With the camcorder's Power Switch set to "A" or "M".	With the camcorder's Power Switch set to "PLAY".
1 Infrared beam transmitting window	Transmits the beam signal.	
2 ZOOM (T/W) Buttons	Zoom in/out (☞ pg. 20)	Zoom in/out (☞ pg. 51)
3 PLAY Button	—	Playback start (☞ pg. 22)
4 REW Button	Retake (rewind), Quick Review (☞ pg. 21, 29)	Rewind, Reverse Shuttle Search, Previous Still Image Playback (☞ pg. 22, 30)
5 STOP Button	—	Stop (☞ pg. 22)
6 INSERT Button	—	Insert Editing (☞ pg. 52, 53)
7 REC TIME Button ANIM. Button	Animation, Time-Lapse (☞ pg. 51)	—
8 START/STOP Button	Functions the same as the Recording Start/Stop Button on the camcorder.	
9 FF Button	Retake (forward) (☞ pg. 21)	Fast-Forward, Forward Shuttle Search, Next Still Image Playback (☞ pg. 22, 30)
10 PAUSE Button	—	Pause (☞ pg. 22)
11 A.DUB Button	—	Audio dubbing (☞ pg. 53)
12 INT. TIME Button SELF TIMER Button*	Time-Lapse (☞ pg. 51)	—

* This function is unavailable with this camcorder.

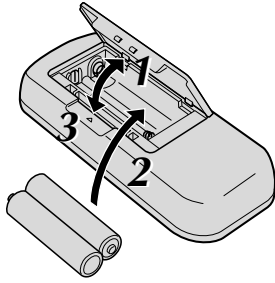

Installing The Batteries

The remote control uses two “AAA (R03)” size batteries. See “General Battery Precautions” (pg. 66).

- 1 Open the battery compartment cover as illustrated.
- 2 Insert two “AAA (R03)” size batteries in the correct direction.
- 3 Replace the battery compartment cover.

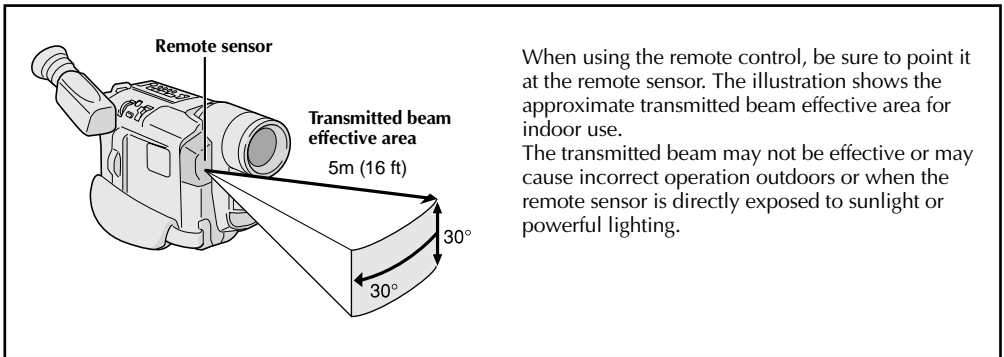

When using the remote control, be sure to point it at the remote sensor. The illustration shows the approximate transmitted beam effective area for indoor use.

The transmitted beam may not be effective or may cause incorrect operation outdoors or when the remote sensor is directly exposed to sunlight or powerful lighting.

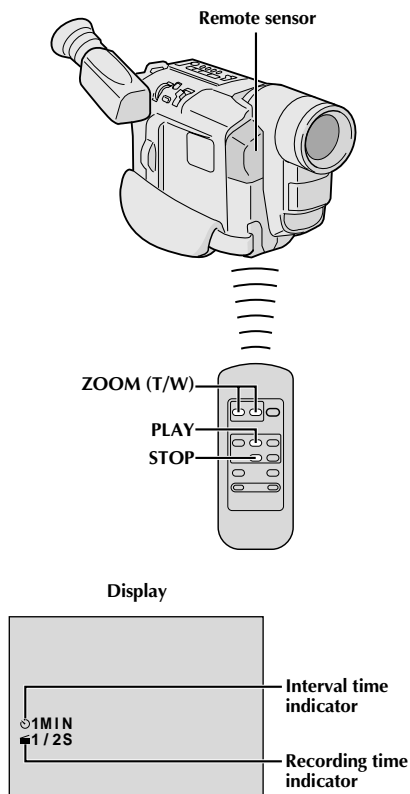

Playback Zoom (GR-SXM930 only)

To magnify the recorded image up to 10X at any time during playback.

NOTES:

- Use the remote control unit to perform this procedure.
- Make sure that the TBC mode is activated (☐ pg. 23).

- 1) Press **PLAY** to find the scene of interest.
- 2) Press the **ZOOM** Buttons (**T/W**) on the remote control.
Make sure the remote control is pointed at the camcorder's remote sensor. Pressing **T** zooms in.

To End Zoom . . .

.... press and hold **W** until magnification returns to normal. Or, press **STOP** and then press **PLAY**.

NOTES:

- Zoom can also be used during still playback.
- Due to digital image processing, the quality of the image may suffer.
- After zooming in on a still video image, when normal playback is started, the zoomed-in effect is momentarily canceled but then resumes, returning magnification to the previously set level.

Animation And Time-Lapse

The remote control lets you set/release Interval Time and Recording Time without using the Menu Screen.

Animation

1) Set

Instead of performing steps **1** and **2** on pg. 48 ("Animation"), press **REC TIME** on the remote control. Each time **REC TIME** is pressed, the Recording Time indicator appears, changing in the following order: 1/4S, 1/2S, 1S, 5S and no indication (off).

2) Release

Instead of using the Menu in step **5** on pg. 48, press **REC TIME** on the remote control until the Recording Time indicator disappears.

Time-Lapse

1) Set

Instead of performing steps **1** and **2** on pg. 48 ("Time-Lapse"), press **REC TIME** and **INT. TIME** on the remote control. Each time **REC TIME** is pressed, the Recording Time indicator appears, changing in the following order: 1/4S, 1/2S, 1S, 5S and no indication (off). Each time **INT. TIME** is pressed, the Interval Time indicator appears, changing in the following order: 15S, 30S, 1MIN, 5MIN and no indication (off).

2) Release

Instead of using the Menu in step **4** on pg. 48 ("Time-Lapse"), press **REC TIME** and **INT. TIME** on the remote control until the indicators disappear.

NOTE:

Also refer to pg. 48.

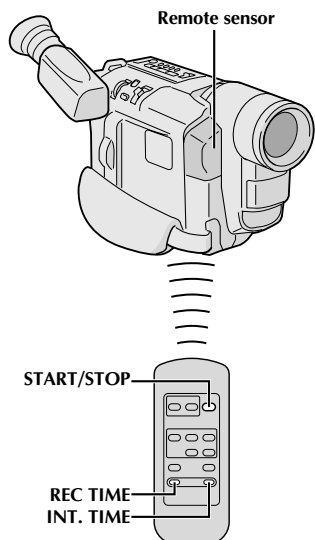

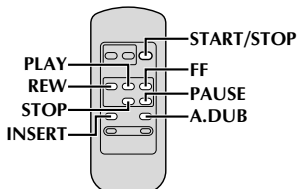
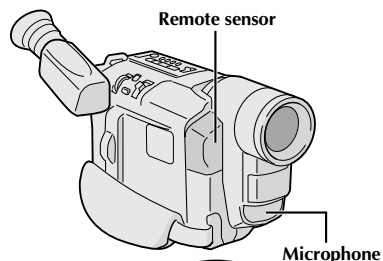
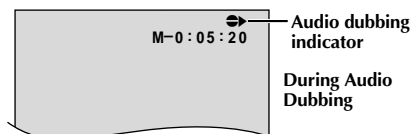
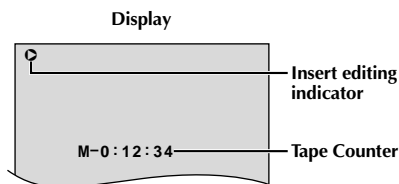
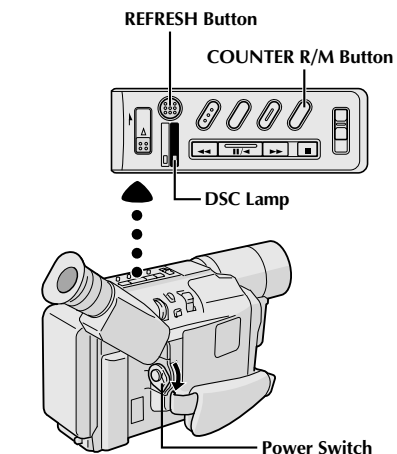

Insert Editing (VIDEO)

You can record a new scene onto a previously recorded tape, replacing a section of the original recording with minimal picture distortion at the in- and out-points. The original audio remains unchanged.

NOTE:

Use the remote control unit to perform this procedure.

- 1** Set the Power Switch to "PLAY". If the DSC Lamp is lit, press **REFRESH** for approx. 1 second to select "VIDEO".
- 2** Play back the tape, locate the Edit-Out point and press **PAUSE** (II).
- 3** Press and hold **COUNTER R/M** on the camcorder for more than 1 second to reset the tape counter, then press it again for less than 1 second so that "M" appears.
- 4** Press **REW** to go a little beyond the beginning of the scene you want to replace, press **PLAY** to view the recorded tape, and press **PAUSE** exactly at the Edit-In point where the new scene should start.
- 5** Press and hold **INSERT**, and without releasing **INSERT**, press and release **PAUSE** on the Remote Control. The Insert Editing indicator appears and the Insert Editing mode is engaged. When the scene the camcorder is aimed at appears on the screen, go to the next step.
- 6** To begin Insert Editing, press **START/STOP**. When the counter reaches "0:00:00", editing stops automatically and the camcorder enters the Insert-Pause mode.
- 7** To end Insert Editing, press **STOP**.

NOTES:

- During Insert Editing, the original audio will be heard from the speaker.
- After step 5, Retake (☐ pg. 21) can be performed.
- The tape may stop slightly before or after the designated end point, and noise bars may appear. Neither indicates a defect in the unit.
- Only the video signal is recorded in the Insert Editing mode.

NOTE:

Use the remote control unit to perform the following procedures.

Insert Editing (Insert A Still Image From The Built-in Memory Onto A Tape)

You can insert a still image stored in the camcorder's built-in memory into a previously recorded tape, replacing a section of the original recording with minimal picture distortion at the in- and out-points. The original audio remains unchanged.

Perform steps 1 through 5 in Insert Editing (VIDEO) (☞ pg. 52) before the following procedure.

1 Press **REFRESH** for approx. 1 second to select "DSC". The DSC Lamp comes on. Press **REW** or **FF** to select the still image you wish to insert.

2 To begin Insert Editing, press **START/STOP**. When the counter reaches "0:00:00", editing stops automatically and the camcorder enters the Insert-Pause mode.

To insert still images in sequential order onto the tape . . .

... press **REW** or **FF** to move the page forward.

To insert still images at random onto the tape . . .

... first record the still image you selected in step 1 onto the tape, then press **START/STOP** to engage the Insert-Pause mode. To select another still image, press **REW** or **FF** again, then press **START/STOP**. Insert Editing begins.

3 To end Insert Editing, press **STOP**.

NOTES:

- The tape may stop slightly before or after the designated end point, and noise bars may appear. Neither indicates a defect in the unit.
- Only video signal is recorded in the Insert Editing mode.

Audio Dubbing

You can record a new soundtrack on a prerecorded tape (normal audio only). The sound is recorded from the built-in microphone.

Perform steps 1, 2 and 3 of the Insert Editing (VIDEO) procedure (☞ pg. 52) before continuing.

1 Press **REW** to go a little beyond the beginning of the scene onto which you want to dub the new audio, press **PLAY** to view the recorded tape, then press **PAUSE** at exactly the point where dubbing should start.

2 Press and hold **A. DUB**, and without releasing **A. DUB**, press and release **PAUSE** on the Remote Control. The Audio Dub-Standby mode is engaged.

3 To begin Audio Dubbing, press **PLAY**. When the counter reaches "0:00:00", Audio Dubbing stops automatically and the camcorder enters the Audio Dub-Standby mode.

4 To end Audio Dubbing, press **STOP**.

NOTES:

- Do not press **FF** or **REW** during Audio Dub-Standby, or the edit points will not be accurate.
- If the microphone is too close to the TV, or if the TV's volume is too high, whistling or howling may occur.

NOTES**(for Insert Editing and Audio Dubbing):**

- Insert Editing and Audio Dubbing may not work correctly if the tape contains blank segments, or if the recording speed was changed during the original recording.
- To edit/dub onto a tape, make sure the Erase Protection tab is in the position that allows recording. If not, slide the tab. Some cassettes have removable tabs. If the tab has been removed, cover the hole with adhesive tape.
- Do not press **STOP** during Insert Editing or Audio Dubbing, or the edit points will not be accurate.
- During Insert Editing and Audio Dubbing, when Insert-Pause or Audio Dub-Standby is engaged, the counter may go slightly past "0:00:00". Recording, however, stops at exactly 0:00:00.

REFERENCES**CONTENTS**

TROUBLESHOOTING	55 – 57
DETAILS	58 – 59
INDEX	60 – 63
Controls, Connectors And Indicators	60 – 61
Indications	62 – 63
TERMS	64 – 65
CAUTIONS	66 – 68
SPECIFICATIONS	69
ESPAÑOL	70 – 73
FOR SERVICING (Only in U.S.A.)	74
WARRANTY (Only in U.S.A.)	75

If, after following the steps in the chart below, the problem still exists, please consult your JVC dealer.

The camcorder is a microcomputer-controlled device. External noise and interference (from a TV, a radio, etc.) might prevent it from functioning properly. In such cases, first disconnect its power supply unit (battery pack, AC Adapter, etc.); and then re-connect it and proceed as usual from the beginning.

SYMPTOM	POSSIBLE CAUSE(S)
POWER	
No power is supplied.	<ul style="list-style-type: none"> ● The battery pack has not been attached correctly (☞ pg. 8). ● The battery pack is not charged (☞ pg. 8). ● The power supply has not been correctly connected (☞ pg. 9).
The power suddenly goes off and does not come back on by itself.	<ul style="list-style-type: none"> ● The battery pack has completely discharged. ● Remove the cassette and disconnect the power source, then after a few minutes, try turning the power back on. If it still does not come on, consult your nearest JVC dealer.
OTHER	
Some functions are not available.	<ul style="list-style-type: none"> ● The Power Switch is set to "A". ● Certain combinations of modes or effects are not possible to use.
During recording, the indications do not appear.	<ul style="list-style-type: none"> ● Set "DISPLAY" to "FULL" in SYSTEM MENU (☞ pg. 42).
Vertical white lines appear when shooting a very bright object.	<ul style="list-style-type: none"> ● This sometimes occurs when the contrast between the background and the object is great. It is not a defect of the camcorder.
Bright, crystal-shaped spots appear in the LCD monitor and the viewfinder.	<ul style="list-style-type: none"> ● Sunlight is directly entering the lens. This is not a defect of the camcorder.
The rear of the LCD monitor is hot.	<ul style="list-style-type: none"> ● The light used to illuminate the LCD monitor causes it to be hot. Close the LCD monitor to turn it off or set the Power Switch to "OFF", and let the unit cool down.
Colored bright spots appear all over the LCD monitor or the viewfinder.	<ul style="list-style-type: none"> ● The LCD monitor and the viewfinder are made with high-precision technology. However, black spots or bright spots of light (red, green or blue) may appear constantly on the LCD monitor or in the viewfinder. These spots are not recorded on the tape. This is not due to any defect of the unit. (Effective dots: more than 99.99 %.)
The indicators and the picture color on the LCD monitor are not clear.	<ul style="list-style-type: none"> ● This may occur when the surface or the edge of the LCD monitor is pressed.
The LCD monitor, the viewfinder and the lens have become dirty (ex. fingerprints).	<ul style="list-style-type: none"> ● Wipe them gently with soft cloth. Gently wipe the LCD monitor in a semicircle because wiping strongly spreads the stain and it won't come out easily.
An error number (i.e. E03) appears.	<ul style="list-style-type: none"> ● Turn the camcorder's power off, then disconnect the power source. After a few minutes, try turning the power on again. If the error number still appears, consult your nearest JVC dealer.
The image is out of focus.	<ul style="list-style-type: none"> ● The diopter needs to be adjusted (☞ pg. 10). ● The scene being shot is adversely affecting the operation of Auto Focus (☞ pg. 45).
Even though the lens cap is detached, the "LENS CAP" warning indicator (☞ pg. 63) blinks.	<ul style="list-style-type: none"> ● The "LENS CAP" warning indicator may blink when the camcorder is used in dark areas, regardless of whether the lens cap is attached or detached.

When "VIDEO" is selected (the DSC Lamp is not lit):

SYMPTOM	POSSIBLE CAUSE(S)
RECORDING	
Recording cannot be performed.	<ul style="list-style-type: none"> ● Make sure the Erase Protection tab is in the position that allows recording. If not, slide the tab. Some cassettes have removable tabs. If the tab has been removed, cover the hole with adhesive tape (☞ pg. 15). ● If "DSC" is selected (the DSC Lamp is lit), it is not possible to record onto the tape. Press REFRESH for approx. 1 second to select "VIDEO" (the DSC Lamp is not lit).
Recording does not start.	<ul style="list-style-type: none"> ● The camcorder Power Switch has not been set to "A" or "M" (☞ pg. 18).
Animation or Time-Lapse is not available.	<ul style="list-style-type: none"> ● Before recording in the Animation mode at the very beginning of a tape, set the camcorder to the Recording mode for about 5 seconds, so that the tape runs smoothly. Using the Fade-in function at this point is a good way to begin an animated program (☞ pg. 48).
PLAYBACK	
The tape is running, but there is no playback picture.	<ul style="list-style-type: none"> ● The TV has not been set to its VIDEO mode or channel. ● If A/V connection is used, the TV's VIDEO/TV Switch has not been set to VIDEO.
Playback cannot be performed.	<ul style="list-style-type: none"> ● If "DSC" is selected (the DSC Lamp is lit), it is not possible to play back a tape. Press REFRESH for approx. 1 second to select "VIDEO" (the DSC Lamp is not lit).
Playback picture is blurred or interrupted.	<ul style="list-style-type: none"> ● The video heads are dirty or worn out. Consult your nearest JVC dealer for head cleaning or replacement.
The counter indication is blurred during Still playback.	<ul style="list-style-type: none"> ● This is normal.
TAPE TRANSPORT	
The tape stops during fast-forward or rewind.	<ul style="list-style-type: none"> ● The Counter Memory Function has been activated (☞ pg. 23).
Rewinding or fast-forwarding cannot be performed.	<ul style="list-style-type: none"> ● The tape is already fully wound on one reel or the other.
OTHER	
The picture is blurred in the Quick Review or Retake mode.	<ul style="list-style-type: none"> ● This is normal while recording in the EP mode. Some noise may be present while recording in the SP mode (☞ pg. 14).
The date and time displays disappear.	<ul style="list-style-type: none"> ● If you remove the power source from the camcorder while the power is on, all settings and selections are erased. Make sure to turn the camcorder's power off before disconnecting the power source.
The wrong date and time are displayed/recorded.	<ul style="list-style-type: none"> ● If you have not performed Date/Time Setting (☞ pg. 11), the date and time are not displayed/recorded correctly. Be sure that Date/Time setting is carried out.
The tape will not eject.	<ul style="list-style-type: none"> ● The battery pack is running low. ● If the LCD monitor is not open over 60 degrees, EJECT switch does not function.

When “DSC” is selected (the DSC Lamp is lit):

SYMPTOM	POSSIBLE CAUSE(S)
SHOOTING	
Although SNAPSHOT is pressed, a still image is not stored in the built-in memory.	<ul style="list-style-type: none"> When the number of remaining shots available reaches “0” (blinking), it becomes impossible to take your next shot. Perform “Deleting Images” function to remove some still images already stored in memory (☞ pg. 33).
It is not possible to shoot in succession.	<ul style="list-style-type: none"> A still image is in the process of being stored in memory for approx. 2 seconds after SNAPSHOT is pressed. During that time, it is impossible to take another shot. When the still image disappears and the scene you are currently aimed at appears on the screen, take another shot (☞ pg. 28).
PLAYBACK	
Although “ALL” is selected in the DELETE Menu Screen, all still images cannot be deleted.	<ul style="list-style-type: none"> The “Protecting Images” function is in effect for some still images. If they are not necessary, cancel the “Protecting Images” function, then try deleting all still images again (☞ pg. 32).
OTHER	
Date/Time Insert is not performed while shooting a still image.	<ul style="list-style-type: none"> It is not possible to display the date/time on a still image.
Instant Titles are not displayed while shooting a still image.	<ul style="list-style-type: none"> It is not possible to display the Instant Titles on a still image.
Some settings cannot be changed in the Menu Screen.	<ul style="list-style-type: none"> It is not possible to set “REC TIME” and “INT. TIME” in the Menu Screen.

Since the camcorder is a microcomputer-controlled device, external noise and interference (from a TV, a radio, etc.) might prevent it from functioning properly. For example, when a still image you shot is stored in the camcorder’s built-in memory, the above may cause the following: Although the remaining number of shots indicator shows that shooting is possible, a still image cannot be stored in memory after shooting. In such a case, initialize the memory by following steps **1** through **3** below. Please note that initialization deletes all the still images (including ones for which you performed the “Protect” function) stored in the camcorder’s memory. If you wish to keep any of the still images that are stored in memory, before initialization first transfer them to a PC and save them. If image data is corrupt, transfer is impossible.

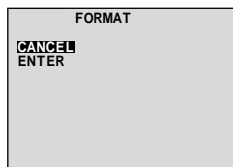

FORMAT Menu

- Set the Power Switch to “**PLAY**”. If the DSC Lamp is not lit, press **REFRESH** for approx. 1 second to select “DSC”.
- Press **P.AE** for more than 5 seconds. The **FORMAT** Menu appears.
- Rotate the **MENU** Wheel to select “**CANCEL**” or “**ENTER**”, then press it.
 - “**CANCEL**” does not initialize the memory.
 - “**ENTER**” initializes the memory. During initialization, “**ENTER**” blinks. When initialization is complete, the screen becomes blue back.

CAUTION:

While “**ENTER**” is selected and it is blinking, switching off the camcorder or removing the power supply unit (battery pack or AC Adapter) may cause the camcorder’s built-in memory to become corrupt. **Never remove the power supply unit at this stage.**

ITEMS	NOTES
<p>⇒ Power (☞ pg. 8)</p>	<ul style="list-style-type: none"> ○ Perform charging where the temperature is between 10°C and 35°C (50°F and 95°F). 20°C to 25°C (68°F to 77°F) is the ideal temperature range for charging. If the environment is too cold, charging may be incomplete. ○ Charging times are for a fully discharged battery pack. ○ Charging time varies according to the ambient temperature and the status of the battery pack. ○ To avoid interference with reception, do not use the AC Adapter near a radio. ○ Since the AC Adapter processes electricity internally, it becomes warm during use. Be sure to use it only in well-ventilated areas. ○ The following operation stops charging or discharging: <ul style="list-style-type: none"> • Set the Power Switch to "PLAY", "A" or "M". • Disconnect the AC Adapter from the camcorder. • Unplug the AC Adapter's power cord from the AC outlet. • Detach the battery from the camcorder.
<p>⇒ Date/Time Settings (☞ pg. 11)</p>	<ul style="list-style-type: none"> ○ The date/time cannot be stored in memory if the built-in clock battery runs out. Consult an authorized JVC dealer for replacement, or set the date/time as necessary before you start shooting.

ITEMS	NOTES
<p>⇒ VIDEO RECORDING (☞ pg. 18, 19)</p>	<ul style="list-style-type: none"> ○ When the Power Switch is set to “A” or “M” and the LCD monitor is opened at an angle of 60 degrees or more, the LCD monitor switches on and the viewfinder switches off automatically to save power. ○ The cassette holder cannot be opened unless a power supply is attached. ○ There may be a delay after you slide EJECT until the cassette holder opens. Do not use force. ○ The time required to calculate the remaining tape length, and the accuracy of the calculation, may vary according to the type of tape used. ○ The tape remaining time indicator is correct only if the correct tape length has been selected (☞ pg. 14). ○ “TAPE END” appears when the tape reaches its end, and the power goes off automatically if left in this condition for 5 minutes. “TAPE END” also appears when a cassette whose tape is already at its end is loaded. ○ If the Recording Start/Stop button is pressed after the Record-Standby mode has continued for over 5 minutes, recording may not start immediately. ○ While shooting, sound is not heard from the speaker.
<p>⇒ TBC (Time Base Corrector) (☞ pg. 23)</p>	<ul style="list-style-type: none"> ○ The “TBC” indicator turns green (gray with a camcorder equipped with a black/white viewfinder) while TBC is working. ○ TBC does not work during still playback and shuttle search. ○ The “TBC” indicator turns white while TBC is not operative. ○ It may take a few seconds before TBC actually starts working. ○ The picture may be distorted if the TBC mode is activated or deactivated at the edit-in/-out points or when normal playback resumes after still playback or shuttle search. ○ If the playback picture is distorted when TBC is set to on, turn off TBC.

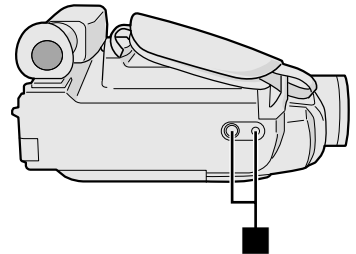
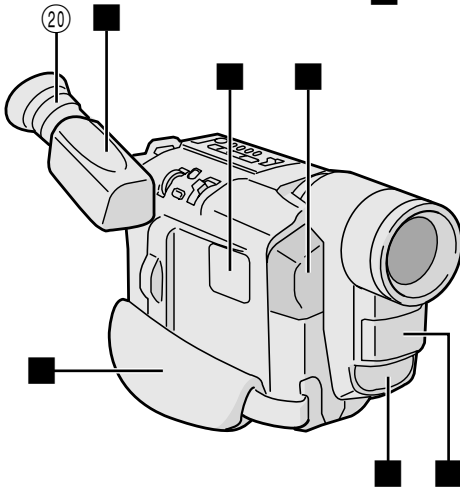
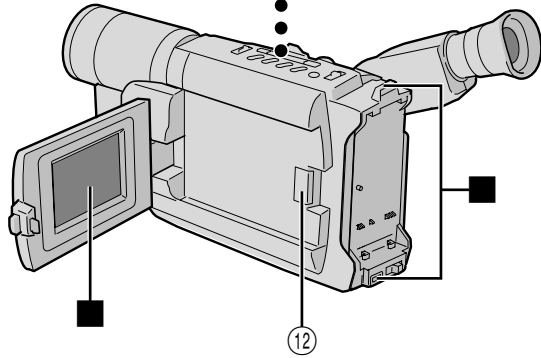
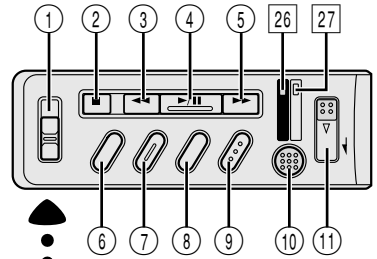
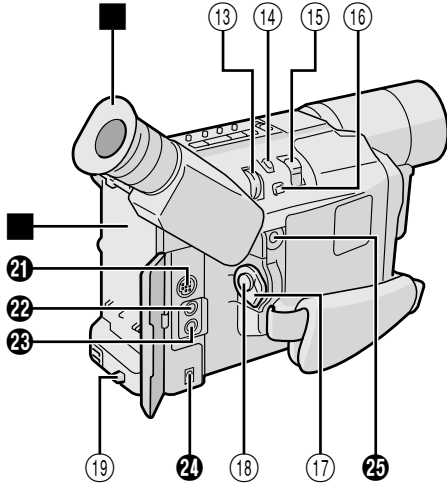

Controls

- ① Video Light Switch
[LIGHT OFF/AUTO/ON] pg. 21
- ② Stop Button [STOP] pg. 22, 29
- ③ • Retake Rewind Button [RETAKE R] pg. 21
• Quick Review Button [Q R] pg. 21, 29
• Rewind Button [R] pg. 22
• Previous Page Button pg. 30
- ④ Play/Pause Button pg. 22, 29
- ⑤ • Retake Forward Button [RETAKE F] pg. 21
• Fast-Forward Button [F] pg. 22
• Next Page Button pg. 30
- ⑥ • Fade/Wipe Button [FADE/WIPE] pg. 37
• Counter Reset/Memory Button
[COUNTER R/M] pg. 23
- ⑦ • Program AE Button [P.AE] pg. 38
• Memory Initialize Button pg. 57
- ⑧ Digital Effect Button [DIGIFECT] pg. 39
- ⑨ NIGHT-ALIVE Button
(GR-SXM930 only) pg. 36
- ⑩ REFRESH Button pg. 8, 18, 22, 28, 30
- ⑪ EJECT Switch pg. 15
- ⑫ Close Button pg. 15
- ⑬ • MENU Wheel [–, +] pg. 40
• BRIGHT Wheel [–, +] pg. 18, 22, 30
• TRACKING Wheel [–, +] pg. 23
- ⑭ Snapshot Button [SNAPSHOT] pg. 28, 43
- ⑮ • Power Zoom Lever [T/W] pg. 20
• Speaker Volume Control [VOL.] pg. 22
- ⑯ • Picture Stabilizer Button
[P. STABILIZER] pg. 20
• Time Base Corrector Button [TBC] pg. 23
- ⑰ Power Switch
[PLAY, OFF, A, M] pg. 18, 22, 28, 30
- ⑱ Recording Start/Stop Button pg. 18
- ⑲ Battery Release Switch
[BATTERY RELEASE] pg. 8
- ⑳ Diopter Adjustment Control pg. 10

Connectors

The connectors ㉑ to ㉔ are located beneath the cover.

- ㉑ S-Video Output Connector [S] pg. 24
- ㉒ Audio Output Connector [A] pg. 24
- ㉓ Video Output Connector [V] pg. 24
- ㉔ DC IN Connector pg. 8, 9
- ㉕ Digital Connector [DIGITAL] pg. 34

Indicators

- ㉖ • DSC Lamp pg. 18, 22, 28, 30
• CHARGE Lamp pg. 8
- ㉗ • VIDEO Lamp pg. 18
• REFRESH Lamp pg. 8

Other Parts

- LCD Monitor pg. 18, 19
- Shoulder Strap Eyelets pg. 10
- Eyepiece
- Battery Pack Mount pg. 8
- Viewfinder pg. 10
- Speaker pg. 22
- • Camera sensor
Be careful not to cover this area; a sensor
necessary for shooting is built-in here.
• Remote Sensor pg. 50
- Grip Strap pg. 10
- Microphone pg. 52
- Video Light pg. 21
- Tripod Mounting Socket pg. 10

Indications During Recording

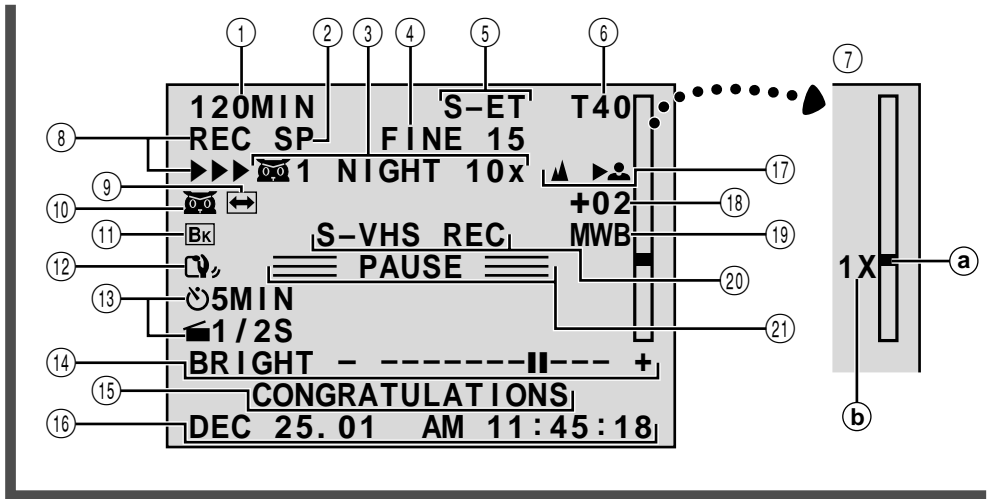

- ① • Tape Remaining Time pg. 59
Blinks when a tape is about to reach its end.
• D.S.C. Mode Indicator pg. 29
“DSC” appears when the D.S.C. mode is selected.
- ② Recording Mode Indicator (SP/EP) pg. 14
- ③, ⑨ Digital Effect Indicator pg. 39
Displayed at ③ for approx. 2 seconds when the Digital Effect is switched from one mode to another by pressing **DIGIFECT**, then only the indicator remains at ⑨.
- ③, ⑩ • Program AE Indicator pg. 38
Displayed at ③ for approx. 2 seconds when Program AE with special effects is switched from one mode to another by pressing **PAE**, then only the indicator remains at ⑩.
• Night-Alive Indicator (GR-SXM930 only) pg. 36
Displayed at ③ for approx. 2 seconds when Night-Alive is switched from one mode to another by pressing **NIGHT-ALIVE**, then only the indicator remains at ⑩.
- ③, ⑪ Fade/Wipe-Standby Indicator pg. 37
Displayed at ③ for approx. 2 seconds when the Fade/Wipe is switched from one effect to another by pressing **FADE/WIPE**, then only the indicator remains at ⑪.
- ④ • Picture Mode Display pg. 16, 29
• Remaining Number Of Shots Indicator pg. 16, 29
- ⑤ Recording Format Indicator (S/S-ET) pg. 12
- ⑥ Tape Length Indicator pg. 14
- ⑦ Zoom Indicator Bar pg. 20
Ⓐ Zoom Level Indicator
Ⓑ Approximate Zoom Ratio
- ⑧ Recording Indicator pg. 18
- ⑫ Picture Stabilizer Indicator pg. 20
- ⑬ Interval Time/Recording Time Indicator pg. 48
- ⑭ Bright Level Indicator pg. 18
- ⑮ Instant Title Display pg. 47
- ⑯ Date/Time Display pg. 47
- ⑰ Focus Indicator pg. 45
- ⑱ Exposure Control Level Counter pg. 44
- ⑲ White Balance Mode Indicator pg. 46
- ⑳ S-VHS/S-VHS ET Recording Indicator ... pg. 12
- ㉑ Record-Standby Mode Indicator pg. 18

Indications During Playback

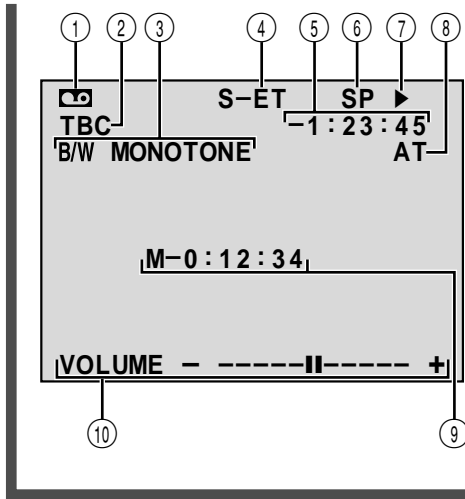

- ① : Cassette Indicator
Displayed when a tape is loaded.
- : Insert Editing Indicator pg. 52
Displayed during Insert Editing.
- ② TBC Indicator pg. 23
- ③ Playback Special Effect Indicator pg. 23
- ④ Recording Format Indicator (S/S-ET) pg. 12
- ⑤ Tape Counter pg. 23, 52
- ⑥ Recording Mode Indicator (SP/EP) pg. 14
- ⑦ Tape Running Indicator
 - : Playback
 - : Fast-Forward/Shuttle Search
 - : Rewind/Shuttle Search
 - : Pause
 - : Audio Dubbing
- ⑧ Tracking Indicator pg. 23
- ⑨ Tape Counter pg. 52
Displayed only during Insert Editing.
- ⑩ • BRIGHT: Bright Level Indicator pg. 22
• VOLUME: Speaker Volume Indicator pg. 22

Warning Indications

Indications	Function
	Displays the battery remaining power. Remaining power level: high. It does not necessarily mean that the battery pack is fully charged. Remaining power level: exhausted As the battery power comes close to nil, the battery indicator blinks (battery power warning). When the battery power is exhausted, power turns off automatically.
	Blinks when no cassette is loaded, or when the Erase Protection tab is not in the position that allows recording. (pg. 15)
TAPE END	Appears when the tape ends during recording, playback or fast-forward. (pg. 59)
LENS CAP	Appears for 5 seconds after power is turned on if the lens cap is attached.
 CONDENSATION OPERATION PAUSED PLEASE WAIT	These 2 warnings appear alternately every 3 seconds if condensation occurs. In this case, all functions except tape eject and power on/off are disabled. Remove the tape, turn the unit off (without removing the power supply), wait a few minutes for the warnings to clear, and turn it on again.
 HEAD CLEANING REQUIRED USE CLEANING CASSETTE	These 2 warnings appear alternately every 3 seconds if dirt is detected on the heads during recording. In this case, use an optional cleaning cassette. If the warning remains after cleaning, consult your nearest JVC dealer.
E01—E06 UNIT IN SAFEGUARD MODE REMOVE AND REATTACH BATTERY	The error indications (E01 — E06) show what type of malfunction has occurred. If an error indication and warning appear, turn the unit off, remove the power supply (battery, etc.) and wait a few minutes for them to clear. When it does, you can resume using the camcorder. If the indication remains, consult your nearest JVC dealer.

A

AC Adapter	pg. 8, 9
Animation Recording	pg. 48, 51
Audio Dubbing	pg. 53
Auto Date Record	pg. 47
Auto Focus	pg. 45
Auto Shut Off	pg. 22, 59

B

Battery Pack	pg. 8, 9, 66
Brighten The Image	pg. 44
Brighten The LCD Monitor	pg. 18

C

Cassette Adapter	pg. 26
Charge Marker	pg. 9
Charging The Battery Pack	pg. 8
Classic Film Effect	pg. 39
Clean The Camcorder	pg. 68
COM Port (RS-232C)	pg. 34
Connection To A VCR/TV	pg. 24
Connection To A Windows® PC	pg. 34
Contents	cover page, 7, 17, 27, 35, 54
Counter Memory	pg. 23

D

Darken The Image	pg. 44
Darken The LCD Monitor	pg. 18
Date/Time Display	pg. 47
Date/Time Settings	pg. 11
DELETE Menu	pg. 33
Delete Mode	pg. 33
Delete Select Menu	pg. 33
Demonstration Mode	pg. 6, 42
Digital Effects	pg. 39
Digital Zoom	pg. 41
Digital Still Camera	pg. 27 – 34
Dioptr Adjustment	pg. 10

E

Electronic Fog Filter Mode	pg. 38
Erase Protection	pg. 15
Exposure Control	pg. 44

F

Fade-In/Out	pg. 37
Fast-Forward Tape	pg. 22
FINE Mode	pg. 16
Fine Still	pg. 22
Full Image	pg. 29, 43

G

Grip Adjustment	pg. 10
-----------------------	--------

H

High Speed Shutter Mode	pg. 38
-------------------------------	--------

I

INDEX Menu	pg. 31
Index Mode	pg. 31
Index Number	pg. 31
Initialization	pg. 57
Insert Editing	pg. 52, 53
Instant Delete	pg. 29
Instant Titles	pg. 47

J

Journalistic Shooting	pg. 19
JPEG	pg. 29

L

LCD monitor/Viewfinder, Indications	pg. 62, 63
Load A Tape	pg. 15

M

Manual Focus	pg. 45
Menu Screen	pg. 40 – 42
Modem Port	pg. 34
Monotone Effect	pg. 39
Move The Page Back	pg. 30
Move The Page Next	pg. 30

N

ND Effect Mode	pg. 38
Nega/Posi Mode	pg. 39
Night-Alive	pg. 36

P

Padlock Mark	pg. 32
Picture Mode Setting	pg. 16
Picture Stabilizer	pg. 20
Pin-Up Image	pg. 29, 43
Playback (D.S.C.)	pg. 30
Playback (VIDEO)	pg. 22
Playback Special Effects	pg. 23
Playback Zoom	pg. 51
Power Switch Position	pg. 18
Printer Port	pg. 34
Program AE With Special Effects	pg. 38
PROTECT Menu	pg. 32
Protect Mode	pg. 32
Provided Accessories	pg. 4

Q

Quick Review	pg. 21, 29
--------------------	------------

R

Recording, Advanced Features	pg. 35 – 48
Recording, Start/Stop (VIDEO)	pg. 18, 19
Recording (D.S.C.)	pg. 28, 29
Recording Format	pg. 12
Recording Mode	pg. 14
Record-Standby	pg. 18
Remote Control	pg. 49
Retake	pg. 21
Rewind The Tape	pg. 22

S

Self-Recording	pg. 19
Sepia Mode	pg. 39
Shoulder Strap Attachment	pg. 10
Shuttle Search	pg. 22
Slide Show Mode	pg. 30
Snapshot During Playback	pg. 43
Snapshot Mode	pg. 28, 43
Snapshot (VIDEO)	pg. 43
Specifications	pg. 69
Sports Mode	pg. 38
STANDARD Mode	pg. 16
Star Mark On The Setting Menus	pg. 31 – 33
Still Image Data Transfer	pg. 34
Still Playback	pg. 22
Store A Still Image In The Built-In Memory	pg. 28
Strobe Effect	pg. 39
Super LoLux (S.LX)	pg. 41
Super VHS Expansion Technology	pg. 12

T

Tape Counter	pg. 23, 52
Tape Dubbing	pg. 24, 25
Tape Length Setting	pg. 14
Tele Macro	pg. 42
Time Base Corrector	pg. 23
Time-Lapse Shooting	pg. 48, 51
Tracking	pg. 23
Tripod Mounting	pg. 10
Twilight Mode	pg. 38

U

Unload A Tape	pg. 15
---------------------	--------

V

Video Echo Effect	pg. 39
Video Light	pg. 21
Viewfinder Adjustment	pg. 10

W

White Balance Adjustment	pg. 46
Wide Mode	pg. 41
Wipe-In/Out	pg. 37

Z

Zooming	pg. 20
---------------	--------

When using the AC Adapter in areas other than the USA

- The provided AC Adapter features automatic voltage selection in the AC range from 110 V to 240 V.

USING HOUSEHOLD AC PLUG ADAPTER

In case of connecting the unit's AC Adapter to an AC wall outlet other than American National Standard C73 series type use an AC plug adapter, called a "Siemens Plug", as shown.

For this AC plug adapter, consult your nearest JVC dealer.

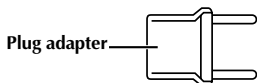

Video Light

DANGER:



- The video light becomes extremely hot. Do not touch it either while in operation or soon after turning it off, otherwise serious injury may result.
- Do not place the camcorder into the carrying case immediately after using the video light, since it remains extremely hot for some time.
- When operating, keep a distance of about 30 cm (11-13/16" ft.) between the video light and people or object.
- Do not use near flammable or explosive materials.
- It is recommended that you consult your nearest JVC dealer for replacing the video light.

General Battery Precautions

If the remote control or cassette adapter is not functioning even if it is being operated correctly, the batteries are exhausted. Replace them with fresh ones.

Use only the following batteries:

Remote control AAA (R03) size x 2 (RM-V715U)
Cassette adapter AA (R6) size x 1 (C-P6U or C-P7U)

Please make note of the following rules for battery use. When misused, the batteries can leak or explode.

1. When replacing batteries, refer to page 50 for the remote control, or read the cassette adapter (C-P6U/C-P7U) instructions.
2. **Do not** use any different size of batteries from those specified.
3. Be sure to install batteries in the correct direction.
4. **Do not** use rechargeable batteries.
5. **Do not** expose the batteries to excessive heat as they can leak or explode.
6. **Do not** dispose of the batteries in a fire.
7. Remove the batteries from the unit if it is to be stored for an extended period to avoid battery leakage which can cause malfunctions.

Battery Packs

The battery packs are nickel-cadmium or nickel metal-hydrate batteries. Before using the supplied battery pack or an optional battery pack, be sure to read the following cautions:

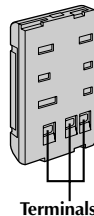

1. **To avoid hazard . . .**
 - **do not** burn.
 - **do not** short-circuit the terminals.
 - **do not** modify or disassemble.
 - use only specified chargers.
2. **To prevent damage and prolong service life . . .**
 - **do not** subject to unnecessary shock.
 - avoid repeated charging without fully discharging.
 - charge in an environment where temperatures are within the tolerances shown in the chart below. This is a chemical reaction type battery—cooler temperatures impede chemical reaction, while warmer temperatures can prevent complete charging.
 - store in a cool, dry place. Extended exposure to high temperatures will increase natural discharge and shorten service life.
 - avoid prolonged uncharged storage.
 - remove from charger or powered unit when not in use, as some machines use current even when switched off.

NOTES:

- *It is normal for the battery pack to be warm after charging, or after use.*
Temperature Range Specifications
Charging 10°C to 35°C (50°F to 95°F)
Operation 0°C to 40°C (32°F to 104°F)
Storage -10°C to 30°C (14°F to 86°F)
- *Recharging time is based on room temperature of 20°C (68°F).*
- *The lower the temperature, the longer recharging takes.*

Cassettes

To properly use and store your cassettes, be sure to read the following cautions:

1. **During use . . .**
 - make sure the cassette bears the S-VHS-C or VHS-C mark.
 - be aware that recording onto prerecorded tapes automatically erases the previously recorded video and audio signals.
 - make sure the cassette is positioned properly when inserting.
 - do not load and unload the cassette repeatedly without allowing the tape to run at all. This slackens the tape and can result in damage.
 - do not open the front tape cover. This exposes the tape to fingerprints and dust.

2. Store cassettes . . .

- ... away from heaters or other heat sources.
- ... out of direct sunlight.
- ... where they won't be subject to unnecessary shock or vibration.
- ... where they won't be exposed to strong magnetic fields (such as those generated by motors, transformers or magnets).
- ... vertically, in their original cases.

Main Unit

1. For safety, DO NOT . . .

- open the camcorder's chassis.
- disassemble or modify the unit.
- short-circuit the terminals of the battery pack. Keep it away from metallic objects when not in use.
- allow inflammables, water or metallic objects to enter the unit.
- remove the battery pack or disconnect the power supply while the power is on.
- leave the battery pack attached when the camcorder is not in use.

2. Avoid using the unit . . .

- in places subject to excessive humidity or dust.
- in places subject to soot or steam such as near a cooking stove.
- in places subject to excessive shock or vibration.
- near a television set.
- near appliances generating strong magnetic or electric fields (speakers, broadcasting antennas, etc.).
- in places subject to extremely high (over 40°C or 104°F) or extremely low (under 0°C or 32°F) temperatures.

3. DO NOT leave the unit . . .

- in places of over 50°C (122°F).
- in places where humidity is extremely low (below 35%) or extremely high (above 80%).
- in direct sunlight.
- in a closed car in summer.
- near a heater.
- in dusty places such as a beach.

4. To protect the unit, DO NOT . . .

- allow it to become wet.
- drop the unit or strike it against hard objects.
- subject it to shock or excessive vibration during transportation.
- keep the lens directed at extremely bright objects for long periods.
- direct the eyepiece of the viewfinder at the sun.
- carry it by holding the viewfinder or the LCD monitor. Be sure to hold the main unit with both hands or use the grip.
- swing it excessively when using the shoulder strap.

LCD Monitor

1. To prevent damage to the LCD monitor, DO NOT . . .

- push it strongly or apply any shocks.
- place the camcorder with the LCD monitor on the bottom.

2. To prolong service life . . .

- avoid rubbing it with coarse cloth.

3. Be aware of the following phenomena for LCD monitor use. These are not malfunctions:

- While using the camcorder, the surface around the LCD monitor and/or the back of the LCD monitor may heat up.
- If you leave power on for a long time, the surface around the LCD monitor becomes hot.

How To Handle a CD-ROM

- Take care not to soil or scratch the mirror surface (opposite to the printed surface). Do not write anything or put a sticker on either the front or back surface. If the CD-ROM gets dirty, gently wipe it with a soft cloth outward from the center hole using a circular motion.
- Do not use conventional disc cleaners or cleaning spray.
- Do not bend the CD-ROM or touch its mirror surface.
- Do not store your CD-ROM in a dusty, hot or humid environment. Keep it away from direct sunlight.

About moisture condensation . . .

- You may have observed that pouring a cold liquid into a glass will cause drops of water to form on the glass' outer surface. This same phenomenon occurs on the head drum of a camcorder when it is moved from a cool place to a warm place, after heating a cold room, under extremely humid conditions or in a place directly subjected to the cool air from an air conditioner.
- Moisture on the head drum can cause severe damage to the video tape, and can lead to internal damage to the camcorder itself.

Serious malfunctioning

If malfunctioning occurs, stop using the unit immediately and consult your local JVC dealer.

For Your Maintenance

1. After Use

- ① Set the Power Switch to "OFF" to turn off the camcorder.
- ② Open the LCD monitor to an angle of over 60 degrees. Slide **EJECT** to open the cassette holder, then remove the cassette.
- ③ Close and lock the cassette holder by pressing the Close button.
- ④ Close and lock the LCD monitor.
- ⑤ Slide **BATTERY RELEASE** to remove the battery pack.
- ⑥ Attach the provided lens cap to the camcorder's lens.

2. Cleaning The Camcorder

- ① **CLEAN EXTERIOR**
Wipe gently with a soft cloth.
Put cloth in diluted mild soap and wring it well to wipe off heavy dirt, then wipe again with a dry cloth.
- ② **CLEAN LCD MONITOR**
Open the LCD monitor and wipe it gently with a soft cloth. Be careful not to damage the monitor. Close the LCD monitor.
- ③ **CLEAN LENS**
Blow it with a blower brush, then wipe it gently with lens cleaning paper.
- ④ **REMOVE EYEPIECE**
Turn the eyepiece counterclockwise and pull it out.
- ⑤ **CLEAN VIEWFINDER**
Remove dust using a blower brush.
- ⑥ **RE-ATTACH EYEPIECE**
Re-attach the eyepiece and turn it clockwise.

NOTES:

- *Avoid using strong cleaning agents such as benzine or alcohol.*
- *Cleaning should be done only after the battery pack has been removed or other power units have been disconnected.*
- *Mold may form if the lens is left dirty.*
- *When using a cleaner or chemically treated cloth, refer to the cautions that came with it.*
- *When removing the eyepiece, be sure to hold the viewfinder securely.*

Declaration of Conformity

Model Number : GR-SXM930U/530U
Trade Name : JVC
Responsible party : JVC AMERICAS CORP.
Address : 1700 Valley Road
 Wayne, N.J. 07470
Telephone Number : (973) 315-5000

This device complies with Part 15 of FCC Rules. Operation is subject to the following two conditions:

(1) This device may not cause harmful interference, and (2) this device must accept any interference received, including interference that may cause undesired operation.

Change or modifications not approved by the party responsible for compliance could void the user's authority to operate the equipment. This equipment has been tested and found to comply with the limits for a Class B digital device, pursuant to Part 15 of the FCC Rules. These limits are designed to provide reasonable protection against harmful interference in a residential installation. This equipment generates, uses, and can radiate radio frequency energy and, if not installed and used in accordance with the instructions, may cause harmful interference to radio communications. However, there is no guarantee that interference will not occur in a particular installation. If this equipment does cause harmful interference to radio or television reception, which can be determined by turning the equipment off and on, the user is encouraged to try to correct the interference by one or more of the following measures:

- Reorient or relocate the receiving antenna.
- Increase the separation between the equipment and receiver.
- Connect the equipment into an outlet on a circuit different from that to which the receiver is connected.
- Consult the dealer or an experienced radio/TV technician for help.

This Class B digital apparatus complies with Canadian ICES-003.

Cet appareil numérique de la classe B est conforme à la norme NMB-003 du Canada.

Camcorder

General

Format : S-VHS/VHS NTSC standard

Power source : DC 11 V ---
 (Using AC Adapter)
 DC 6 V ---
 (Using battery pack)

Power consumption

Viewfinder on : 4.7 W

LCD monitor on : 5.4 W

Video light : 3.0 W

Signal system : NTSC-type

Video recording system

Luminance : FM recording
Color : Converted sub-carrier
 direct recording
 Conforms to VHS standard

Cassette : **S**VHS  / VHS  cassette

Tape speed

SP : 33.35 mm/sec. (1-5/16 ips)

EP : 11.12 mm/sec. (7/16 ips)

Recording time (max.)

SP : 40 minutes

EP : 120 minutes (with TC-40)

D.S.C. format

Recording format : Digital data storage
 (based on JPEG)

Recording medium : Built-in flash memory,
 2 Mbyte

Number of storable shots

FINE mode : approx. 30 shots

STANDARD mode : approx. 60 shots

Image size : 640 x 480 pixels
 (when captured on a PC)

Operating temperature

: 0°C to 40°C (32°F to 104°F)

Operating humidity : 35% to 80%

Storage temperature : -20°C to 50°C
 (-4°F to 122°F)

Weight : Approx. 930 g (2.1 lbs)
 (GR-SXM930 only)
 Approx. 920 g (2.1 lbs)
 (GR-SXM530 only)

Dimensions : 206 mm x 112 mm x 118 mm
 (8-1/8" x 4-7/16" x 4-11/16")
 (with the LCD monitor closed
 and with the viewfinder fully
 tilted downward)

Pickup : 1/4" format CCD

Lens : F1.6, f = 3.9 mm to 62.4 mm,
 16:1 power zoom lens with
 auto iris and macro control,
 filter diameter 40.5 mm

Viewfinder : Electronic viewfinder with
 0.55" color LCD
 (GR-SXM930 only)
 Electronic viewfinder with
 0.5" black/white CRT
 (GR-SXM530 only)

White balance adjustment : Auto/Manual adjustment

LCD monitor : 3" diagonally measured, LCD
 panel/TFT active matrix
 system (GR-SXM930 only)
 2.5" diagonally measured,
 LCD panel/TFT active matrix
 system (GR-SXM530 only)

Speaker : Monaural

Connectors

Video : 1 V (p-p), 75 Ω unbalanced,
 analog output
 (via Video output connector)

Audio : 300 mV (rms), 1 k Ω analog
 output
 (via Audio output connector)

Digital : \varnothing 2.5 mm, 4-pole, mini-head
 jack

S-Video : **Y** : 1 V (p-p), 75 Ω ,
 analog output
C : 0.29 V (p-p), 75 Ω ,
 analog output

AC Adapter AP-V10U

Power requirement

U.S.A. and Canada : AC 120 V \sim , 60 Hz



Other countries : AC 110 V to 240 V \sim ,
 50 Hz/60 Hz

Output : DC 11 V --- , 1 A

Dimensions : 59 mm x 31 mm x
 (W x H x D)
 69 mm (2-3/8" x 1-1/4" x
 2-3/4")

Weight : Approx. 130 g (0.29 lbs)

Optional Accessories

- **Battery Packs BN-V12U, BN-V20U, BN-V400U**
- **A/V (Audio/Video) Cable**
- **S-Video Cable QAM0004-004**
- **Compact S-VHS (**S**VHS ) Cassettes ST-C-40/30/20**
- **Compact VHS (**V**HS ) Cassettes TC-40/30/20**
- **Active Carrying Bag CB-V7U**

Some accessories are not available in some areas.
 Please consult your nearest JVC dealer for details on
 accessories and their availability.

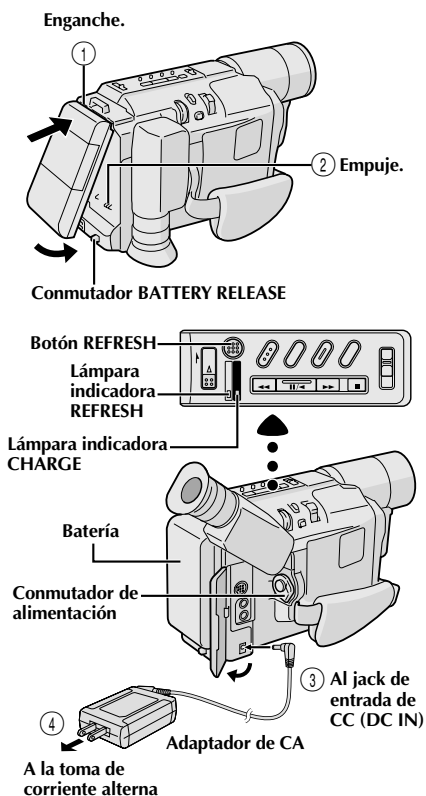

Alimentación

Esta videocámara posee un sistema de alimentación de 2 vías que le permite seleccionar la fuente de alimentación más apropiada. No utilice las unidades de alimentación suministradas con otro equipo.

CARGA DE LA BATERIA

- 1 Asegúrese de que la batería esté colocada en la videocámara. Enganche el extremo a la videocámara ① y presione la batería hacia el interior hasta que quede bloqueada en su lugar ②.
 - Si la batería está colocada en la posición equivocada, puede ocurrir un fallo.
- 2 Ajuste el conmutador de alimentación en "OFF". Conecte el adaptador de alimentación CA a la videocámara ③.
- 3 Enchufe el adaptador de alimentación CA en una toma de corriente alterna ④. La lámpara indicadora CHARGE de la videocámara parpadeará para indicar que la carga se ha iniciado.
- 4 Cuando la lámpara indicadora CHARGE pare de parpadear, pero permanece encendida, la carga ha finalizado. Desenchufe el adaptador de alimentación CA de la toma de corriente alterna. Desconecte el adaptador de alimentación CA de la videocámara.

Para la extracción de la batería . . .

..... deslice **BATTERY RELEASE** y extraiga la batería.

NOTAS:

- Durante la carga o descarga, la videocámara no puede ser operada.
- No es posible efectuar la carga ni la descarga, si se está utilizando un tipo equivocado de batería.
- Cuando se carga la batería por primera vez o después de un periodo largo de almacenamiento, la lámpara indicadora CHARGE puede no encenderse. En este caso, retire la batería de la videocámara, luego intente la carga nuevamente.
- Si el tiempo de funcionamiento de la batería queda extremadamente corto aun después de haber sido completamente cargada, la batería está estropeada y necesita ser reemplazada. Sírvase comprar una nueva.
- Utilizando el adaptador/cargador de alimentación CA AA-V15 opcional, es posible cargar las baterías BN-V11U/V12U/V20U/V400U sin la videocámara. Sin embargo, éste no podrá ser usado como un adaptador CA.

Batería	Tiempo de carga
BN-V11U	aprox. 1 h 30 min
BN-V12U (opcional)	aprox. 1 h 30 min
BN-V20U (opcional)	aprox. 2 h 20 min
BN-V400U (opcional)	aprox. 4 h 30 min

REFRESCO:

Cargar una batería que todavía posee algo de carga restante reduce la capacidad de la batería. Efectúe el procedimiento de abajo para descargar completamente la batería antes de realizar la recarga.

1. Efectúe los pasos 1 al 3 de "CARGA DE LA BATERIA".
2. Presione **REFRESH** en la videocámara durante más de 2 segundos. La lámpara indicadora REFRESH de la videocámara parpadeará para indicar que la descarga se ha iniciado.
3. Cuando la descarga finaliza, la carga se iniciará automáticamente y la lámpara indicadora CHARGE parpadeará.

Cuando no use una batería recargable durante un intervalo prolongado, asegúrese de descargarla completamente antes de almacenarla, ya que dejar una batería con algo de carga restante también reduce su rendimiento.

ATENCIÓN:

Antes de desmontar la fuente de alimentación, asegúrese que la alimentación de la videocámara esté desconectada. El no hacerlo puede producir un error de funcionamiento en la videocámara.

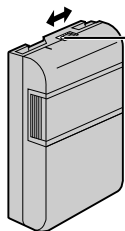
**Indicador de carga**

Está provisto de un indicador de carga sobre la batería para ayudarle a recordar si ha sido cargada o no. Los dos colores indicadores (rojo y negro), le permiten seleccionar la carga y la descarga.

USO DE LA BATERIA

Efectúe el paso 1 de "CARGA DE LA BATERIA" (☞ p. 70).

Tiempo de grabación aproximado (unidad: min)

Batería	Visor conectado	Monitor LCD conectado
BN-V11U	80 (45)	65 (35)
BN-V12U (opcional)	80 (45)	65 (35)
BN-V20U (opcional)	130 (75)	105 (60)
BN-V400U (opcional)	305 (185)	245 (160)

() : cuando el foco de video está encendido

NOTAS:

- El tiempo de grabación es reducido sensiblemente bajo las siguientes condiciones:
 - El modo zoom o modo de espera de grabación es activado repetidas veces.
 - EL monitor LCD es usado repetidas veces.
- Antes del uso prolongado, se recomienda la preparación de baterías suficientes para cubrir 3 veces el tiempo planeado de filmación.

USO DE ALIMENTACION CON CA

Utilice el adaptador de CA (conectado como se muestra en la ilustración).

NOTAS:

- El adaptador de CA se caracteriza por un selector automático de voltaje con límites de CA que van de 110 V a 240 V.
- Para otras notas, ☞ p. 58.

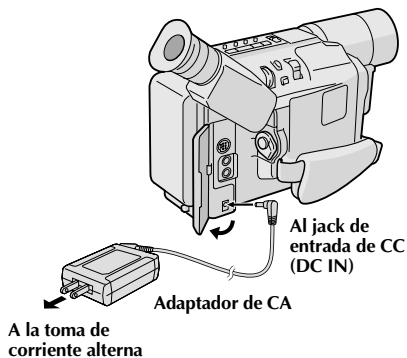

Si la unidad comienza a funcionar mal, deje de usarla inmediatamente y consulte a su concesionario local de JVC.

ALIMENTACION

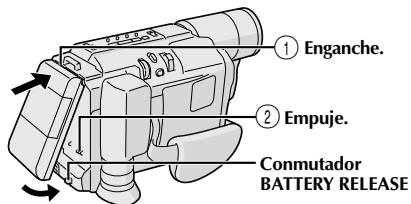

Utilización de la batería

Enganche el lado extremo de la batería en la cámara de video ① y empuje la batería hasta que se bloquee en el lugar ②.

(Procedimiento para carga, ☞ p. 8)

Para extraer la batería

Deslice **BATTERY RELEASE** y extraiga la batería.

INSERCIÓN DEL CASSETTE DE VIDEO

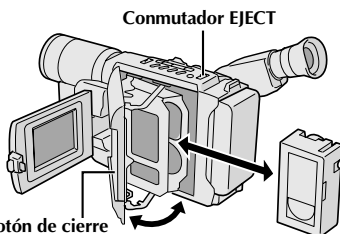

- Abra el monitor LCD completamente.
 - Deslice **EJECT** para abrir el portacassette.
 - Inserte cassette de video.
 - Presione el botón de cierre para cerrar el portacassette.
- (Por más detalles, ☞ p. 15)

REPRODUCCION

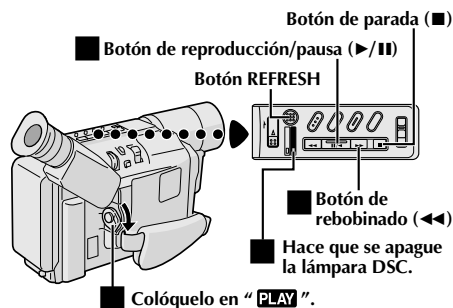

- Ajuste el conmutador de alimentación en "PLAY".
 - Si la lámpara DSC está encendida, presione **REFRESH** durante aprox. 1 segundo para seleccionar "VIDEO".
 - Presione ◀◀.
 - La cinta se detiene automáticamente al comienzo de la misma.
 - Presione ▶/II.
 - Comienza la reproducción y la imagen aparece.
 - Presione ■ para detener la grabación.
- (Por más detalles, ☞ p. 22.)
- El visor se desconecta automáticamente para ahorrar energía cuando el monitor LCD es abierto a un ángulo mayor de 60 grados.
 - El monitor LCD se activa/desactiva cuando se lo abre/cierre a 60 grados aprox.

O simplemente reproduzca la cinta en un VCR de VHS utilizando el adaptador de cassette (VHS Playpak). ☞ p. 26

FILMACION

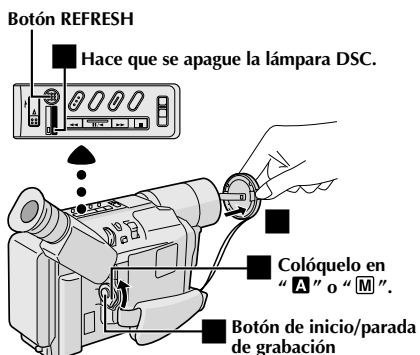

- Presione las lengüetas del cubreobjetivo para retirarlo.
 - Ajuste el conmutador de alimentación en "A" o "M".
 - La lámpara VIDEO se encenderá y aparecerá una imagen.
 - Si la lámpara DSC está encendida, presione **REFRESH** durante aprox. 1 segundo para seleccionar "VIDEO".
 - Presione el botón inicio/parada de grabación.
 - Comenzará la grabación.
 - Para detener temporalmente la grabación, presione nuevamente el botón de inicio/parada de grabación.
- (Por más detalles, ☞ p. 18, 19)
- El visor se desconecta automáticamente para ahorrar energía cuando el monitor LCD es abierto a un ángulo mayor de 60 grados.
 - El monitor LCD se activa/desactiva cuando se lo abre/cierre a 60 grados aprox.

Si la unidad comienza a funcionar mal, deje de usarla inmediatamente y consulte a su concesionario local de JVC.

ALIMENTACION

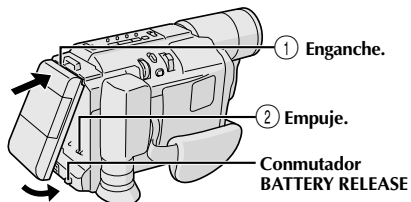

Utilización de la batería

Enganche el lado extremo de la batería en la cámara de video ① y empuje la batería hasta que se bloquee en el lugar ②.

(Procedimiento para carga, p. 8)

Para extraer la batería

Deslice **BATTERY RELEASE** y extraiga la batería.

REPRODUCCION

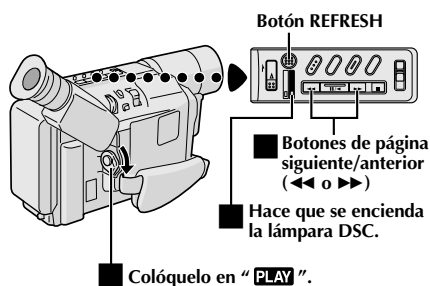

■ Ajuste el conmutador de alimentación en "**PLAY**".

— Aparece una imagen fija almacenada en la memoria.

■ Si la lámpara DSC no está encendida, presione **REFRESH** durante aprox. 1 segundo para seleccionar "DSC".

■ Presione ◀◀ o ▶▶ para seleccionar la imagen fija que desea ver.

(Por más detalles, p. 30.)

• El visor se desconecta automáticamente para ahorrar energía cuando el monitor LCD es abierto a un ángulo mayor de 60 grados.

• El monitor LCD se activa/desactiva cuando se lo abre/cierre a 60 grados aprox.

FILMACION

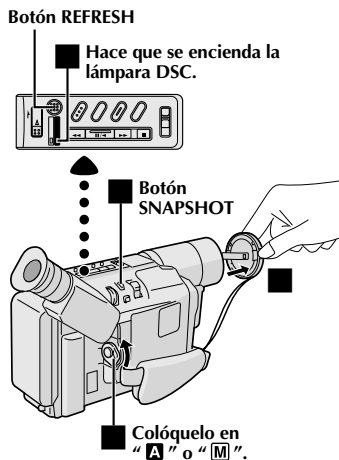

■ Presione las lengüetas del cubreobjetivo para retirarlo.

■ Ajuste el conmutador de alimentación en "**A**" o "**M**".

— La lámpara VIDEO se encenderá y aparecerá una imagen.

■ Si la lámpara DSC no está encendida, presione **REFRESH** durante aprox. 1 segundo para seleccionar "DSC".

■ Presione el botón **SNAPSHOT**.
— Una imagen fija es filmada y almacenada en la memoria de la cámara de video.

(Por más detalles, p. 28, 29)

• El visor se desconecta automáticamente para ahorrar energía cuando el monitor LCD es abierto a un ángulo mayor de 60 grados.

• El monitor LCD se activa/desactiva cuando se lo abre/cierre a 60 grados aprox.

HOW TO LOCATE YOUR JVC SERVICE CENTER**TOLL FREE: 1-800-252-5722****Dear customer:**

In order to receive the most satisfaction from your purchase, read the instruction booklet before operating the unit. In the event that repair is necessary, or for the address nearest your location, please refer to the factory service center list below or within the Continental United States, call 1-800-252-5722 for your authorized servicer. Remember to retain your Bill of Sale for Warranty Service.

— JVC

**JVC SERVICE & ENGINEERING
COMPANY OF AMERICA**
DIVISION OF JVC AMERICAS CORP.
FACTORY SERVICE CENTER LOCATIONS

10 New Maple Avenue
Pine Brook, NJ 07058-9641
(973) 396-1000

1500 Lakes Parkway
Lawrenceville, GA 30243-5857
(770) 339-2522

705 Enterprise Street
Aurora, IL 60504-8135
(630) 851-7855

5665 Corporate Avenue
Cypress, CA 90630-4727
(714) 229-8011

10700 Hammerly Blvd., Suite 110
Houston, TX 77043-2310
(713) 935-9331

2969 Mapunapuna Place, Suite 105
Honolulu, HI 96819-2000
(808) 833-5828

13 Cummings Park
Woburn, MA 01801
(781) 376-9100

8192 West State Road 84
Davie, FL 33324-4611
(954) 472-1960

890 Dubuque Avenue
South San Francisco, CA 94080-1804
(650) 871-2666

Sophisticated electronic products may require occasional service. Just as quality is a keyword in the engineering and production of the wide array of JVC products, service is the key to maintaining the high level performance for which JVC is world famous. The JVC service and engineering organization stands behind our products.

**NATIONAL HEADQUARTERS
JVC SERVICE & ENGINEERING COMPANY OF AMERICA
DIVISION OF JVC AMERICAS CORP.**

10 New Maple Avenue
Pine Brook, NJ 07058-9641

If you ship the product...

Pack your JVC unit in the original carton or one of equivalent size and strength. Enclose, with the unit, a letter stating the problem or symptom that exists and also a copy of the receipt or bill of sale you received when you purchased your JVC unit. Print your home return address on the outside and the inside of the carton. Send to the appropriate JVC Factory Service Center as listed above.

ACCESSORIES

To purchase accessories for your JVC product, you may contact your local JVC Dealer.
Or from the 48 Continental United States call toll free:
1-800-882-2345.

Don't service it yourself.**CAUTION**

To prevent electrical shock, do not open the cabinet. No user serviceable parts inside.
Refer servicing to qualified service personnel.

LIMITED WARRANTY

CONSUMER VIDEO 1-90

JVC COMPANY OF AMERICA warrants this product and all parts thereof, except as set forth below ONLY TO THE ORIGINAL PURCHASER AT RETAIL to be FREE FROM DEFECTIVE MATERIALS AND WORKMANSHIP from the date of original retail purchase for the period as shown below. ("The Warranty Period")

PARTS	1 YR	LABOR	90 DAYS
-------	-------------	-------	----------------

THIS LIMITED WARRANTY IS VALID ONLY IN THE FIFTY (50) UNITED STATES, THE DISTRICT OF COLUMBIA AND IN THE COMMONWEALTH OF PUERTO RICO.

WHAT WE WILL DO:

If this product is found to be defective, JVC will repair or replace defective parts at no charge to the original owner. Such repair and replacement services shall be rendered by JVC during normal business hours at JVC authorized service centers. Parts used for replacement are warranted only for the remainder of the Warranty Period. All products and parts thereof may be brought to a JVC authorized service center on a carry-in basis except for Television sets having a screen size 25 inches and above which are covered on an in-home basis.

WHAT YOU MUST DO FOR WARRANTY SERVICE:

Return your product to a JVC authorized service center with a copy of your bill of sale. For your nearest JVC authorized service center, please call toll free: (800) 537-5722.

If service is not available locally, box the product carefully, preferably in the original carton, and ship, insured, with a copy of your bill of sale plus a letter of explanation of the problem to the nearest JVC Factory Service Center, the name and location of which will be given to you by the toll-free number.

If you have any questions concerning your JVC Product, please contact our Customer Relations Department.

WHAT IS NOT COVERED:

This limited warranty provided by JVC does not cover:

1. Products which have been subject to abuse, accident, alteration, modification, tampering, negligence, misuse, faulty installation, lack of reasonable care, or if repaired or serviced by anyone other than a service facility authorized by JVC to render such service, or if affixed to any attachment not provided with the products, or if the model or serial number has been altered, tampered with, defaced or removed;
2. Initial installation and installation and removal for repair;
3. Operational adjustments covered in the Owner's Manual, normal maintenance, video and audio head cleaning;
4. Damage that occurs in shipment, due to act of God, and cosmetic damage;
5. Signal reception problems and failures due to line power surge;
6. Video Pick-up Tubes/CCD Image Sensor, Cartridge, Stylus (Needle) are covered for 90 days from the date of purchase;
7. Accessories;
8. Batteries (except that Rechargeable Batteries are covered for 90 days from the date of purchase);from the date of purchase);

There are no other express warranties except as listed above.

THE DURATION OF ANY IMPLIED WARRANTIES INCLUDING THE IMPLIED WARRANTY OF MERCHANTABILITY, IS LIMITED TO THE DURATION OF THE EXPRESS WARRANTY HEREIN.

JVC SHALL NOT BE LIABLE FOR THE LOSS OF USE OF THE PRODUCT, INCONVENIENCE, LOSS OR ANY OTHER DAMAGES, WHETHER DIRECT, INCIDENTAL OR CONSEQUENTIAL (INCLUDING, WITHOUT LIMITATION, DAMAGE TO TAPES, RECORDS OR DISCS) RESULTING FROM THE USE OF THIS PRODUCT, OR ARISING OUT OF ANY BREACH OF THIS WARRANTY. ALL EXPRESS AND IMPLIED WARRANTIES, INCLUDING THE WARRANTIES OF MERCHANTABILITY AND FITNESS FOR PARTICULAR PURPOSE, ARE LIMITED TO THE WARRANTY PERIOD SET FORTH ABOVE.

Some states do not allow the exclusion of incidental or consequential damages or limitations on how long an implied warranty lasts, so these limitations or exclusions may not apply to you. This warranty gives you specific legal rights and you may also have other rights which vary from state to state.

JVC COMPANY OF AMERICA 1700 Valley Road
DIVISION OF JVC AMERICAS CORP. Wayne, N.J. 07470

REFURBISHED PRODUCTS CARRY A SEPARATE WARRANTY, THIS WARRANTY DOES NOT APPLY. FOR DETAILS OF REFURBISHED PRODUCT WARRANTY, PLEASE REFER TO THE REFURBISHED PRODUCT WARRANTY INFORMATION PACKAGED WITH EACH REFURBISHED PRODUCT.

For customer use:

Enter below the Model No. and Serial No. which is located either on the rear, bottom or side of the cabinet. Retain this information for future reference.

Model No.: _____

Serial No.: _____

Purchase date: _____

Name of dealer: _____